

**18 Series
General Purpose Pressure Regulator
1 1/2" and 2" Port Sizes**

- The R18 with the conventional integral pilot provides good pressure regulation, rapid response to changing flow demands, and excellent stability.
- The R18 with the feedback integral pilot provides superior pressure regulation under changing flow demands where changes in flow demand are not sudden or cyclic.
- Balanced valve minimises effect of changes in inlet pressure on outlet pressure
- Constant bleed feature in pilot regulator provides quick response and minimum dead-band
- Exceptionally high relief flow
- Full flow gauge ports
- Low torque, non-rising adjusting knob
- Integral locking device on knob adjustment

Technical Data

Fluid: Compressed air

Inlet pressure range: 0,7 bar (10 psig) minimum to 31 bar (450 psig) maximum

Operating temperature: -18° to +80°C (0° to +175°F) *

* Air supply must be dry enough to avoid ice formation at temperatures below +2°C (+35°F).

Typical flow with 0,7 bar (100 psig) inlet pressure, 6,3 bar (90 psig) set pressure, and a droop of 1 bar (15 psig) from set:
944 dm³/s (2 000 scfm)

Gauge ports:

1/4" PTF with PTF main ports

G1/4 with ISO G main ports

R1/4 with ISO Rc main ports

Exhaust port:

3/4" PTF with PTF main ports

G3/4 with ISO G main ports

R3/4 with ISO Rc main ports

Maximum bleed rate: 0,12 dm³/s (0.25 scfm) at 3,5 bar (50 psig) outlet pressure.

Materials:

Body: Aluminium

Bonnet: Aluminium

Bottom Plug: Aluminium

Valve:

Integral Pilot Regulator: Teflon

Pilot Operated Regulator: Aluminium

Elastomers: Nitrile

Ordering Information

See *Ordering Information* on following pages.

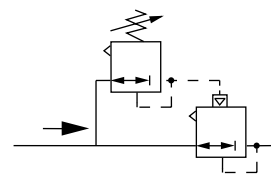
ISO Symbols

R18 with Conventional Pilot Regulator

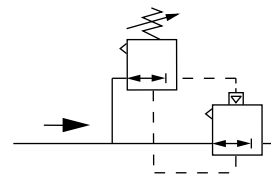

R18 with Feedback Pilot Regulator



Typical Performance Characteristics

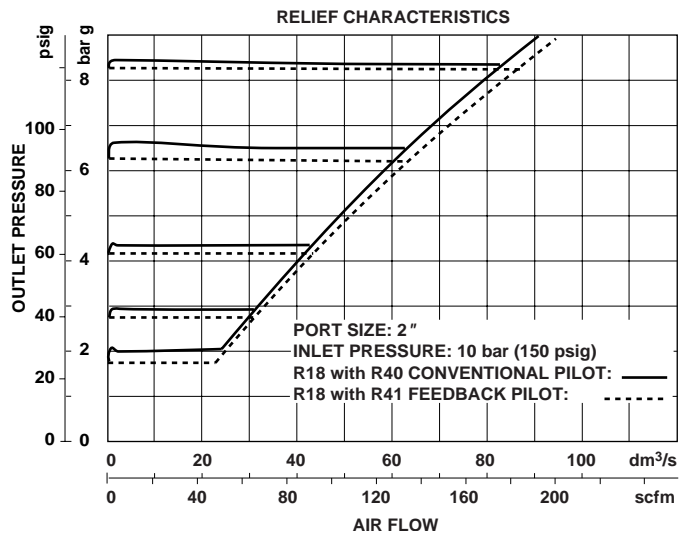
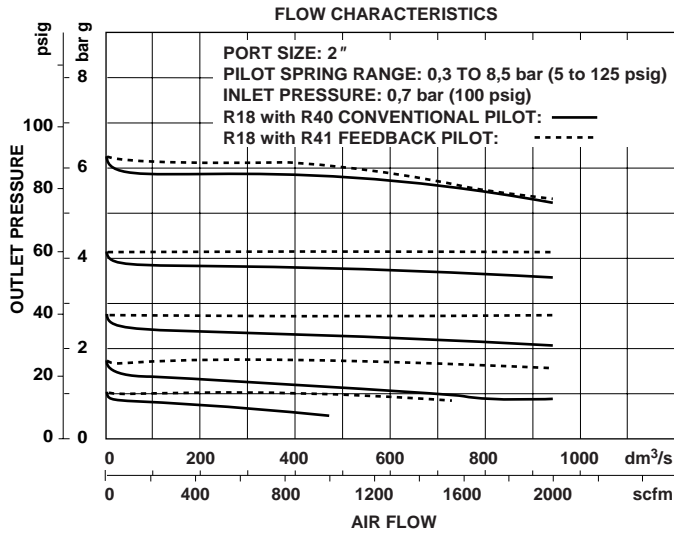

Ordering Information. Models listed include R40 conventional integral pilot, relieving diaphragm, without gauge, 0,3 to 8,5 bar (5 to 125 psig) outlet pressure adjustment range*, and ISO G threads.

Port Size	Model	Flow† dm ³ /s (scfm)	Weight kg (lb)
G1 1/2	R18-B05-RNLG	944 (2000)	3.85 (8.48)
G2	R18-C05-RNLG	944 (2000)	3.75 (8.27)

† Typical flow with 0,7 bar (100 psig) inlet pressure, 6,3 bar (90 psig) set pressure and a droop of 1 bar (15 psig) from set.

Alternative Models

R 1 8 - ★ ★ ★ - ★ ★ ★ ★

Port Size	Substitute
1 1/2"	B
2"	C

Pilot Regulator Type	Substitute
R40 Conventional	05
R41 Feedback **	06

Port Threads	Substitute
PTF	A
ISO Rc taper	B
ISO G parallel	G

Outlet Pressure Adjustment Ranges*	Substitute
5 to 50 psig (0,3 to 3,5 bar)	E
5 to 125 psig (0,3 to 8,5 bar)	L
10 to 250 psig (0,7 to 17 bar)	S

Gauge	Substitute
With	G
Without	N

Diaphragm	Substitute
Relieving	R
Non relieving	N

* Outlet pressures can be adjusted to pressures in excess or, and less than, those specified. Do not use these units to control pressures outside of the specified ranges.

** Requires relieving diaphragm and 17 bar (250 psig) spring (R in 7th position and S in 9th position) e.g. R18-B06-R N S G .

Accessories

Exhaust muffler	Tamper resistant accessory	Ø 50 mm Pressure Gauge	R1/4 Connection	1/4 PTF Connection
3/4" PTF: MB006A	Seal wire: 2117-01	4 bar (60 psig):	18-013-266	18-013-208
R3/4: MB006B		10 bar (160 psig):	18-013-260	18-013-209
		20 bar (300 psig):	18-013-267	18-013-210



Dimensions – mm (Inches)

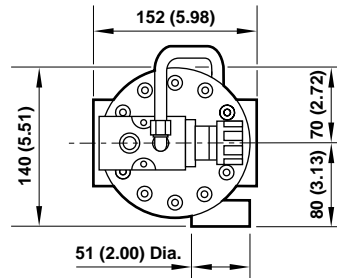
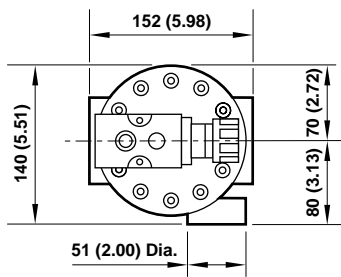

R18 with R40 Conventional Integral Pilot Regulator

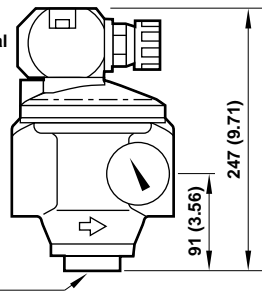

R18 with R41 Feedback Integral Pilot Regulator

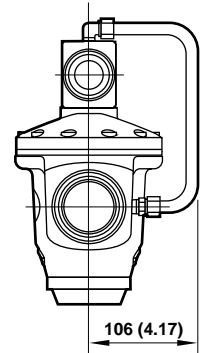
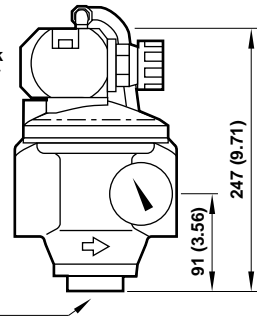

Service Kits

Item	Type	Part number
Service kits	R18 Pilot operated regulator*	5945-40
	R40 and R41 Pilot regulators**	5945-41

- * Contains filter screen and all o-rings for R18 pilot operated regulator.
- ** Contains diaphragm, valve spring, valve, guide bushing, filter screen, and all o-rings for R40 and R41 pilot regulators.



Warning

These products are intended for use in industrial compressed air systems only. Do not use these products where *pressures* and *temperatures* can exceed those listed under '**Technical Data**'.

Before using these products with fluids other than those specified, for non-industrial applications, life-support systems, or other applications not within published specifications, consult Norgren.

Through misuse, age, or malfunction, components used in fluid power systems can fail in various modes. The system designer is warned to consider the failure modes of all component parts used in fluid power systems and to provide adequate safeguards to prevent personal injury or damage to equipment in the event of such failure.

System designers must provide a warning to end users in the system instructional manual if protection against a failure mode cannot be adequately provided.

System designers and end users are cautioned to review specific warnings found in instruction sheets packed and shipped with these products.

**18 Series
Pilot Operated Pressure Regulator
1 1/2" and 2" Port Sizes**

- The R18 *PILOT OPERATED REGULATOR* can be installed at any point in the compressed air system without regard to accessibility. The *PILOT REGULATOR* can be installed in an accessible location, remote from the R18.
- R18 can be used with a *CONVENTIONAL PILOT REGULATOR* to provide good pressure regulation, rapid response to changing flow demands, and excellent stability.
- R18 can be used with a *FEEDBACK PILOT REGULATOR* to provide superior pressure regulation under changing flow demands where changes in flow demand are not sudden or cyclic.
- Balanced valve minimizes effect of changes in inlet pressure on outlet pressure.
- Constant bleed feature in pilot regulator provides quick response and minimum dead-band
- Exceptionally high relief flow.

Technical Data

Fluid: Compressed air

Inlet pressure range: 0,7 bar (10 psig) minimum to 31 bar (450 psig) maximum

Operating temperature: -18° to +80°C (0° to +175°F) *

* Air supply must be dry enough to avoid ice formation at temperatures below +2°C (+35°F).

R18 typical flow with 0,7 bar (100 psig) inlet pressure, 6,3 bar (90 psig) set pressure, and a droop of 1 bar (15 psig) from set: 950 dm³/s (2 000 scfm)

R18 main ports: 1 1/2" or 2" ISO G

R18 pilot and gauge ports: 1/4 ISO G

R18 exhaust port: 3/4" ISO G

11 400, 20ALX, 11-204 pilot ports: 1/4" ISO G

11-204 feedback port: 1/8" ISO G

Materials:

R18

Body, bonnet, bottom plug, valve: Aluminium

Elastomers: Nitrile

11 400, 20ALX, 11-204

Body, bonnet: Zinc

Handwheel: Acetal resin

Valve: Brass

Elastomers: Nitrile

Ordering Information

See *Ordering Information* on the following pages.

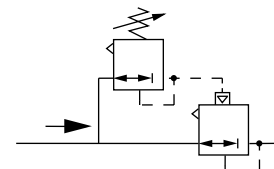
ISO Symbols

R18 with Conventional Pilot Regulator

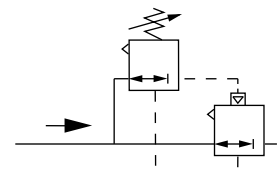

R18 with Feedback Pilot Regulator

Warning - Feedback Pilot Regulators

The feedback line must sense the pilot operated regulator outlet pressure and must be connected before turning on the air supply. If it is not connected, the pilot operated regulator outlet pressure will rapidly increase to the inlet pressure when the adjusting knob on the pilot operator is turned clockwise.



Typical Performance Characteristics

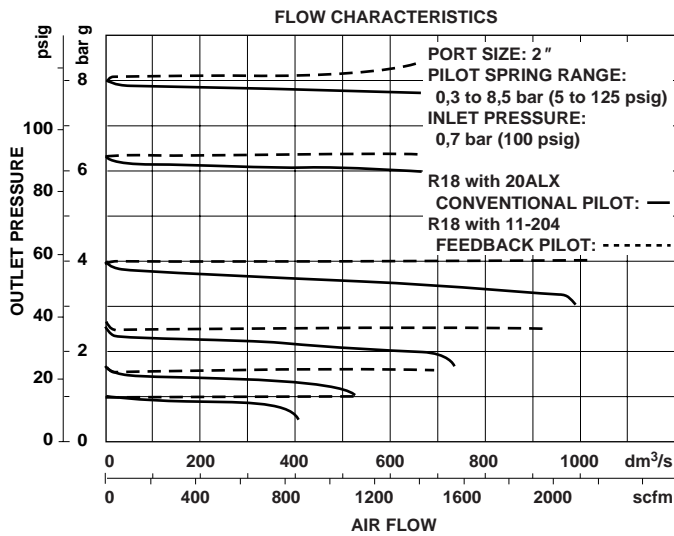

Ordering Information, R18 Pilot Operated Regulator

Models listed include relieving diaphragm and ISO G threads. Also order a remote pilot regulator below.

Port Size	Model	Flow* dm ³ /s (scfm)	Weight kg (lb)
G1 1/2	R18-B00-RNXG	944 (2 000)	3,09 (6.82)
G2	R18-C00-RNXG	944 (2 000)	2,99 (6.61)

* Typical flow with 0,7 bar (100 psig) inlet pressure, 6,3 bar (90 psig) set pressure and a droop of 1 bar (15 psig) from set.

Alternative Models - R18

R 1 8 - ★ 0 0 - ★ ★ X ★

Port Size	Substitute	Threads	Substitute
1 1/2"	B	ISO G parallel	G
2"	C		
Diaphragm	Substitute	Gauge	Substitute
Relieving	R	Without	N
Non relieving (do not use with a feedback pilot regulator)	N		

Ordering Information, 11 400, 20AL-X Remote Pilot Regulators

Models listed are relieving with constant bleed, 0,7 to 17 bar (10 to 250 psig) outlet pressure adjustment range**, ISO G ports.

Port Size	Model	Range bar (psig)	Weight kg (lb)
G1/4	11 400-2G (2 bar)	0,06 to 2 (1 to 30)	0,90 (1.98)
G1/4	11 400-2G (4 bar)	0,06 to 4 (1 to 60)	0,94 (2.07)
G1/4	11 400-2G (7 bar)	0,16 to 7 (2 to 100)	1,00 (2.20)
G1/4	20AL-X2G	7 to 20 (100 to 300)	1,05 (2.30)

Ordering Information, 11-204 Remote Pilot Regulator



Models listed are relieving with constant bleed, 0,3 to 7 bar (5 to 100 psig) outlet pressure adjustment range**, ISO G ports.

Port Size	Model	Range bar (psig)	Weight kg (lb)
G1/4	11-204-004	0,16 to 7 (2 to 100)	1,10 (2.42)
G1/4	11-204-006	4 to 17 (60 to 250)	1,10 (2.42)

** Outlet pressures can be adjusted to pressures in excess or, and less than, those specified. Do not use these units to control pressures outside of the specified ranges.

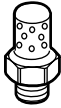
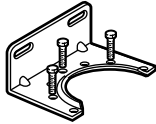

Accessories

				
R18 Exhaust muffler R3/4: MB006B	All Pilots Wall Mounting Bracket 18-001-005	Panel Mount Kit - pilot only (includes threaded bonnet) 11 400 series: 18-003-999 20AL-X series 18-003-026 (not needed for 11-204 series)	Ø 50 mm Pressure Gauge 1,6 bar (23 psig) 4 bar (60 psig) 6 bar (90 psig) 10 bar (150 psig) 25 bar (350 psig)	R1/8 Connection 18-013-010 18-013-011 18-013-012 18-013-013 18-013-014

Dimensions – mm (Inches)

Panel mounting hole diameter (pilot only): 28 mm (1.10")

Panel thickness: 5 to 10 mm (0.2 to 0.4")

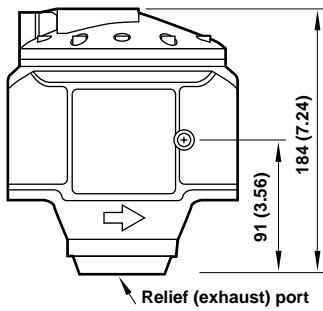
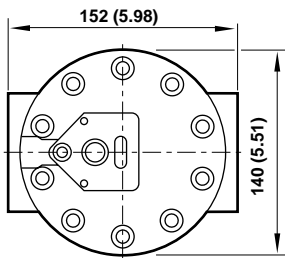

R18 Pilot Operated Regulator

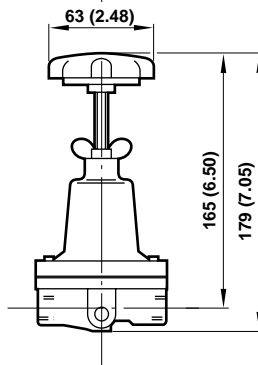
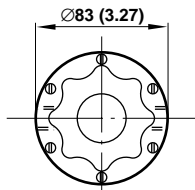

11 400 Conventional Pilot Regulator
(panel mounting dimensions as 11-204.
See accessories.)

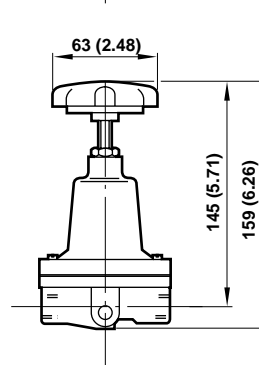
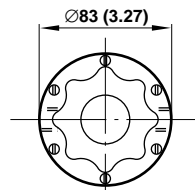

20AL-X Conventional Pilot Regulator
(panel mounting dimensions as 11-204.
See accessories.)

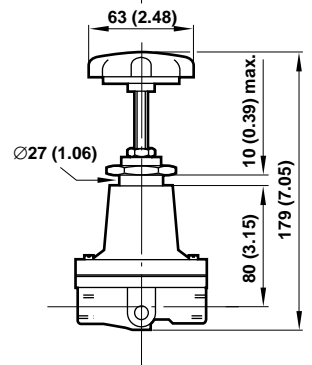
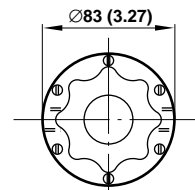

11-204 Feedback Pilot Regulator
with Panel Nut
(includes panel mounting nut)



Bracket Mounting

Bracket Kit Reference

Item	Part Number
All pilots	18-001-005

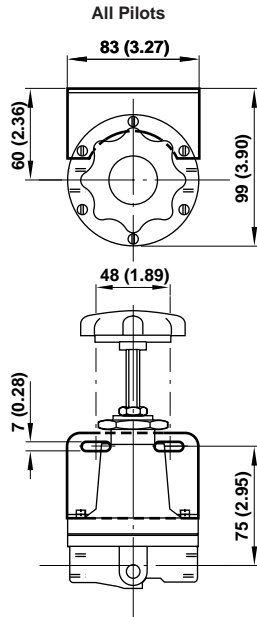

Service Kits

Type	Part number
R18 gasket kit	R18-GK
R18 service kit, relieving	R18-100R
R18 service kit, non relieving	R18-100N
11 400, 20AL-X, service kit	11,400-100
11-204, service kit	11-204-100

R18 service kit contains filter screen and all o-rings.

11 400, 20AL-X service kit contains diaphragm, valve spring, guide bushing, valve, valve spring, filter screen, and all o-rings.

11-204 service kit contains diaphragm, valve pin, valve springs, valve seat, valve ball, and all o-rings.

Warning

These products are intended for use in industrial compressed air systems only. Do not use these products where *pressures* and *temperatures* can exceed those listed under 'Technical Data'.

Before using these products with fluids other than those specified, for non-industrial applications, life-support systems, or other applications not within published specifications, consult Norgren.

Through misuse, age, or malfunction, components used in fluid power systems can fail in various modes. The system designer is warned to consider the failure modes of all component parts used in fluid power systems and to provide adequate safeguards to prevent personal injury or damage to equipment in the event of such failure.

System designers must provide a warning to end users in the system instructional manual if protection against a failure mode cannot be adequately provided.

System designers and end users are cautioned to review specific warnings found in instruction sheets packed and shipped with these products.