

## Pneufit D Acetal push-in fittings, metric Ø 4 ... 12 mm O/D tube

Appropriate for inert gas and industrial air applications and suited for use in medical and analytical equipment for fluid and gas control.

Pneufit® D fittings are manufactured from FDA approved acetal materials.

Certified by NSF (51 & 61), WRAS and SKZert for use with water and food.

Fittings are ready to use, offering fast assembly with no need for tools providing optimum flow.



### Technical features

**Medium:**

Air and liquids

**Operating pressure:**

4 ... 8 mm -20 ... +20°C 15 bar  
 10... 12 mm -20 ... +20°C 12 bar  
 4 ... 8 mm +20 ... +65°C 10 bar  
 10 ... 12 mm +20 ... +65°C 7 bar  
 Vacuum: 749,3 mmHg

**Tube sizes:**

4, 5, 6, 8, 10 and 12 mm

**Thread sizes:**

1/8, 1/4, 3/8, 1/2 inch  
 BSPT, BSPP, UNF and UNS

**Tubing types:**

PA, PUR with 85 ... 95 Shore A hardness  
 PE with 33 ... 52 Shore D hardness

**Operating temperature:**

-20 ... +65°C

**Additional ranges:**

Full range of Inch sizes available  
 contact Norgren Technical services

**Materials**

Body: Acetal  
 Seals: NBR  
 Release Sleeve: Acetal  
 Grab ring: Stainless Steel

### Method of assembly



1. Ensure that the end of the tube is cut square and is free from burrs.



2. Push the tube through the collet into the fitting.



3. Continue pushing the tube through the 'O'-ring until it bottoms on the tube stop then pull back.

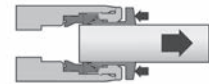

4. To disconnect push the tube into the fitting, hold down the collet and withdraw the tube.

### Option selector

D0 ★★★★★★

Thread type  
 Shape

Thread size/tube size  
 Thread size/tube size

### Straight adaptors and connectors

<p>Straight union D0020</p>  <p>Page 3</p>	<p>Straight union (unequal) D0020</p>  <p>Page 3</p>	<p>Straight adaptor (taper) D0125</p>  <p>Page 3</p>	<p>Straight adaptor (parallel) D0225</p>  <p>Page 3</p>	<p>Female adaptor (UNF-V type) D042B ... Y</p>  <p>Page 3</p>	<p>Female adaptor (taper) D012C</p>  <p>Page 3</p>
<p>Female adaptor (UNS cone type) D042D ... W</p>  <p>Page 4</p>	<p>Female adaptor (UNF cone type) D042D ... Y</p>  <p>Page 4</p>	<p>Female adaptor (flat type) D022C</p>  <p>Page 3</p>	<p>Female adaptor (cone type) D022D</p>  <p>Page 4</p>	<p>Bulkhead union D0029</p>  <p>Page 4</p>	<p>Stem tail piece adaptor D0039</p>  <p>Page 4</p>
<p>Stem reducer (stem/tube) D0023</p>  <p>Page 4</p>	<p>Stem adaptor (stem/male thread) D0115</p>  <p>Page 4</p>	<p>Stem adaptor BSP(P) D0215</p>  <p>Page 5</p>	<p>End stop (female plug) D000A</p>  <p>Page 9</p>	<p>Plug D0004</p>  <p>Page 8</p>	





### Elbow adaptors and connectors

<p>Union elbow D0040</p>  <p>Page 5</p>	<p>Ebrow adaptor D0145</p>  <p>Page 5</p>	<p>90° Swivel elbow adaptor D0147</p>  <p>Page 5</p>	<p>90° Swivel elbow adaptor (BSPP) D0247</p>  <p>Page 5</p>	<p>45° Elbow adaptor D005A</p>  <p>Page 6</p>	<p>Stem elbow D0043</p>  <p>Page 6</p>
-------------------------------------------------------------------------------------------------------------------------------	---------------------------------------------------------------------------------------------------------------------------------	--------------------------------------------------------------------------------------------------------------------------------------------	---------------------------------------------------------------------------------------------------------------------------------------------------	---------------------------------------------------------------------------------------------------------------------------------------	--------------------------------------------------------------------------------------------------------------------------------

### Tee connectors and adaptors

<p>Union tee D0060</p>  <p>Page 6</p>	<p>Union tee (reducing) D006A</p>  <p>Page 6</p>	<p>Union tee (reducing) D006B</p>  <p>Page 6</p>	<p>Swivel tee adaptor D0167</p>  <p>Page 6</p>	<p>Swivel side tee adaptor D0168</p>  <p>Page 6</p>	<p>Swivel tee adaptor D0267</p>  <p>Page 7</p>	<p>Swivel side tee adaptor D0268</p>  <p>Page 7</p>
------------------------------------------------------------------------------------------------------------------------------	-----------------------------------------------------------------------------------------------------------------------------------------	-----------------------------------------------------------------------------------------------------------------------------------------	---------------------------------------------------------------------------------------------------------------------------------------	---------------------------------------------------------------------------------------------------------------------------------------------	-----------------------------------------------------------------------------------------------------------------------------------------	----------------------------------------------------------------------------------------------------------------------------------------------





### Y and quadruple connectors

<p>Union Y D0082</p>  <p>Page 7</p>	<p>U bend D0089</p>  <p>Page 7</p>	<p>Union cross D0090</p>  <p>Page 7</p>	<p>3 way splitter D0091</p>  <p>Page 8</p>
----------------------------------------------------------------------------------------------------------------------------	---------------------------------------------------------------------------------------------------------------------------	--------------------------------------------------------------------------------------------------------------------------------	-----------------------------------------------------------------------------------------------------------------------------------





### In-line non-return valve

<p>In-line non-return valve D00GL</p>  <p>Page 8</p>
---------------------------------------------------------------------------------------------------------------------------------------------

### Hand valves

<p>2/2 shut-off (tube/tube) D00GR</p>  <p>Page 8</p>	<p>2/2 shut-off (tube/male thread) D01GT</p>  <p>Page 8</p>	<p>2/2 shut-off (tube/ female thread) D01GU</p>  <p>Page 8</p>	<p>Shut-off valve mounting clip (for valve ø 10 only) D00GM1000</p>  <p>Page 8</p>
---------------------------------------------------------------------------------------------------------------------------------------------	----------------------------------------------------------------------------------------------------------------------------------------------------	--------------------------------------------------------------------------------------------------------------------------------------------------------	-----------------------------------------------------------------------------------------------------------------------------------------------------------------------------

### Accessories

<p>Tube supports D0033</p>  <p>Page 8</p>	<p>Tube supports for double seal tube support D0033****H</p>  <p>Page 10</p>	<p>Flow bend tube clip D005B</p>  <p>Page 10</p>	<p>Locking clip D0LC</p>  <p>Page 10</p>	<p>Cartridges (brass) D0008</p>  <p>Page 10</p>
----------------------------------------------------------------------------------------------------------------------------------	---------------------------------------------------------------------------------------------------------------------------------------------------------------------	-----------------------------------------------------------------------------------------------------------------------------------------	----------------------------------------------------------------------------------------------------------------------------------	------------------------------------------------------------------------------------------------------------------------------------------

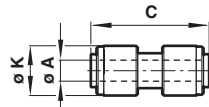
**Straight union  
D0020**

Ø A	C	Ø K	Model
4	34,5	13	D00200400
5	34,5	13	D00200500
6	35,5	15	D00200600
8	41	17,5	D00200800
10	41,5	20	D00201000
12	50	23	D00201200

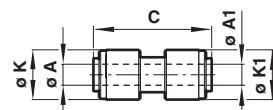
**Straight union (unequal)  
D0020**

Ø A	Ø A1	C	Ø K	Ø K1	Model
6	4	34,5	15	15	D00200604
6	5	35,5	15	15	D00200605
8	4	42	17,5	13	D00200804
8	5	42	17,5	13	D00200805
8	6	41	17,5	17,5	D00200806
10	4	37,5	20	13	D00201004
10	5	37,5	20	13	D00201005
10	6	41	20	20	D00201006
10	8	41,5	20	20	D00201008
12	8	49	23	23	D00201208
12	10	49,5	23	23	D00201210

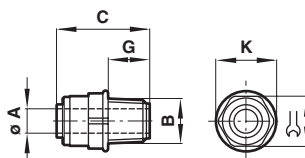
**Straight adaptor (taper)  
D0125**

Ø A	B	C	G	Ø K	Model	
4	R1/8	23,5	9,5	14	9/16"	D01250418
4	R1/4	28,5	13,5	13	11/16"	D01250428
5	R1/8	23,5	9,5	13	9/16"	D01250518
5	R1/4	28,5	13,5	13	11/16"	D01250528
6	R1/8	26	9,5	15	11/16"	D01250618
6	R1/4	28	13,5	15	11/16"	D01250628
6	R3/8	25,5	13,5	15	13/16"	D01250638
6	R1/2	33	17,5	20	1"	D01250648
8	R1/8	26,5	9,5	17,5	13/16"	D01250818
8	R1/4	26,5	13,5	17,5	13/16"	D01250828
8	R3/8	28,5	13,5	17,5	13/16"	D01250838
10	R1/8	31	9,5	20	13/16"	D01251018
10	R1/4	31	13,5	20	13/16"	D01251028
10	R3/8	33	13,5	20	13/16"	D01251038
10	R1/2	36,5	17,5	20	1"	D01251048
12	R3/8	34,5	14	23	1"	D01251238
12	R1/2	34,5	17,5	23	1"	D01251248

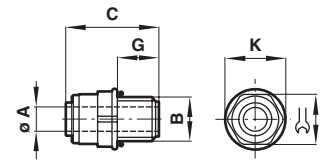
**Straight adaptor (parallel)  
D0225**

Ø A	B	C	G	Ø K	Model	
4	G1/8	23,5	6,5	14	9/16"	D02250418
4	G1/4	28,5	10	16,5	11/16"	D02250428
5	G1/8	25	6,5	17	9/16"	D02250518
5	G1/4	29	10	20,5	11/16"	D02250528
6	G1/8	26	6,5	17	9/16"	D02250618
6	G1/4	28	8	16,5	11/16"	D02250628
8	G1/8	26,5	6,5	20	13/16"	D02250818
8	G1/4	26,5	8	20	1"	D02250828
8	G3/8	28,5	10	20	13/16"	D02250838
10	G1/4	33,5	10	20	11/16"	D02251028
10	G3/8	29	10	24,5	13/16"	D02251038
10	G1/2	33,5	13,5	24,5	1"	D02251048
12	G3/8	34,5	13,5	24,5	13/16"	D02251238
12	G1/2	34,5	13,5	24,5	1"	D02251248

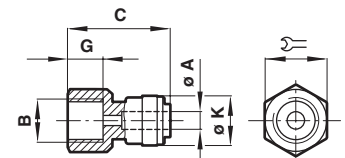
**Female adaptor (UNF-V type)  
D042B ... Y**

Ø A	B	C	G	Ø K	Model	
6	7/16-20	31	11,5	15	3/4"	D042B062Y
8	7/16-20	33	11,5	17,5	3/4"	D042B082Y
10	7/16-20	35,5	11,5	20	3/4"	D042B102Y
10	5/8-18	35,5	14	20	3/4"	D042B104Y

**Female adaptor (taper)  
D012C**

Ø A	B	C	G	Ø K	Model	
6	G1/8	31	11,5	15	3/4"	D012C0618
6	G1/4	31	11,5	15	3/4"	D012C0628
8	G1/8	33	11,5	17,5	3/4"	D012C0818
8	G1/4	33	11,5	17,5	3/4"	D012C0828
10	G1/8	35,5	11,5	20	3/4"	D012C1018
10	G1/4	35,5	11,5	20	3/4"	D012C1028

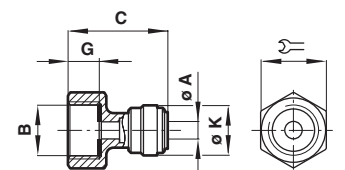
**Female adaptor (flat type)  
D022C**

Ø A	B	C	G	Ø K	Model	
8	G5/8	41,5	13,5	20	1 1/4"	D022C0858
10	G1/2	41	10,5	20	1"	D022C1048
10	G5/8	41,5	13,5	20	1 1/4"	D022C1058
12	G3/8	41,5	10,5	23	1"	D022C1238
12	G1/2	41,5	10,5	23	1"	D022C1248

**Female adaptor (cone type)  
D022D**

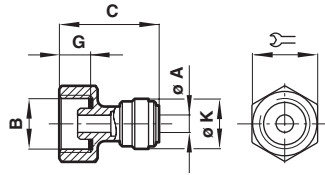

Ø A	B	C	G	Ø K	Symbol	Model
6	G3/8	35,5	10,5	15	7/8"	D022D0638
6	G1/2	36	10,5	15	1"	D022D0648
8	G3/8	38,5	10,5	17,5	7/8"	D022D0838
8	G1/2	38,5	10,5	17,5	1"	D022D0848
10	G3/8	40	10,5	20	7/8"	D022D1038
10	G1/2	41	10,5	20	1"	D022D1048
10	G5/8	41,5	13,5	20	1 1/4"	D022D1058
12	G5/8	41,5	13,5	23	1 1/4"	D022D1258

**Female adaptor (UNS cone type)  
D042D ... W**

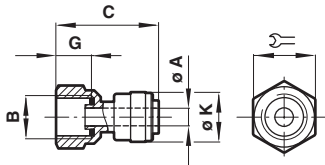

Ø A	B	C	G	Ø K	Symbol	Model
6	7/16-24	31	6,5	15	3/4"	D042D062W
8	7/16-24	33	6,5	17,5	3/4"	D042D082W
10	7/16-24	35,5	6,5	20	3/4"	D042D102W

**Female adaptor (UNF cone type)  
D042D ... Y**

Ø A	B	C	G	Ø K	Symbol	Model
6	7/16-20	31	11	15	3/4"	D042D062Y
8	7/16-20	33	11	17,5	3/4"	D042D082Y
10	7/16-20	35,5	11	20	3/4"	D042D102Y

**Bulkhead union  
D0029**

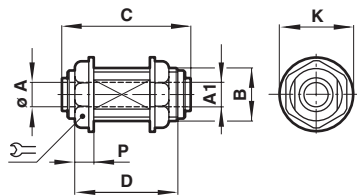

Ø A	Ø A1	B	C	D	Ø K	P	Symbol	Model
4	4	M16x1	33	30,5	22,5	5,5	3/4"	D00290400
5	5	M16x1	34,5	31,5	22,5	5,5	3/4"	D00290500
6	6	M16x1	35	32	22,5	5,5	3/4"	D00290600
6	10	M20x1,5	40	36,5	26,5	6,5	7/8"	D00290610
10	6	M20x1,5	39,5	37	26,5	6,5	7/8"	D00291006
10	10	M20x1,5	40,5	37,5	26,5	6,5	7/8"	D00291000
12	12	M27x1,5	49,5	45	14	8	1 1/8"	D00291200

**Stem tail piece adaptor  
D0039**

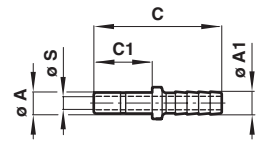

Ø A	Ø A1	C	C1	Ø S	Model
6	4,5	38,5	17,5	1,9	D00390604
8	6,5	39,5	18,5	3,9	D00390806
10	8,5	43,5	22	4,9	D00391008
12	10	46	25	6,8	D00391210

**Stem reducer (stem/tube)  
D0023**

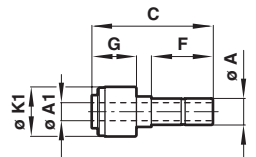

Ø A	Ø A1	C	F	G	Ø K1	Model
4	4	M16x1	33	30,5	22,5	5,5
5	5	M16x1	34,5	31,5	22,5	5,5
6	6	M16x1	35	32	22,5	5,5
6	10	M20x1,5	40	36,5	26,5	6,5
10	6	M20x1,5	39,5	37	26,5	6,5
10	10	M20x1,5	40,5	37,5	26,5	6,5
12	12	M27x1,5	49,5	45	14	8

**Stem adaptor (stem/male thread)  
D0115**

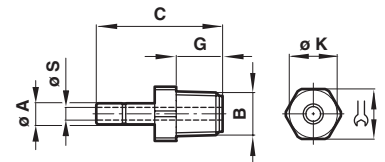

Ø A	B	C	G	Ø K	Ø S	Symbol	Model
4	R1/8	33	10	15	2,5	9/16"	D01150418
4	R1/4	36,5	13,5	18	2,5	11/16"	D01150428
5	R1/8	33	10	15,5	3	9/16"	D01150518
5	R1/4	36	13,5	18	3	11/16"	D01150528
6	R1/8	34	10	15	4,3	9/16"	D01150618
6	R1/4	38	14	18	4,3	11/16"	D01150628
8	R1/8	34,5	10	15	4,8	9/16"	D01150818
8	R1/4	39,5	14	18	4,8	11/16"	D01150828
8	R3/8	39,5	14	22	4,8	13/16"	D01150838
10	R1/4	42,5	14	18	6,5	11/16"	D01151028
10	R3/8	43	14	22	6,5	13/16"	D01151038
10	R1/2	46	17,5	27	6,7	1"	D01151048
12	R3/8	48	14	27	6,7	1"	D01151238
12	R1/2	51	19	28	6,7	1"	D01151248

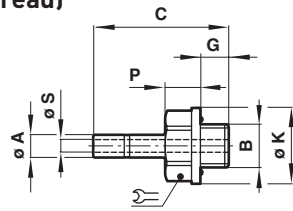
**Stem adaptor (stem/male thread)  
D0215**

Ø A	B	C	G	Ø K	P	Ø S	Symbol	Model
4	G1/8	30,5	6,5	17	8	2,5	9/16"	D02150418
4	G1/4	34,5	10	20,5	8	2,5	11/16"	D02150428
5	G1/8	31	6,5	17	8	3	9/16"	D02150518
5	G1/4	34,5	10	20,5	8	3	11/16"	D02150528
6	G1/8	32	6,5	17	8	4,3	9/16"	D02150618
6	G1/4	35,5	10	20,5	8	4,3	11/16"	D02150628
8	G1/8	33	6,5	17	8	4,8	13/16"	D02150818
8	G1/4	36,5	10	20,5	8	4,8	1"	D02150828
8	G3/8	37	10	26,5	8	4,8	13/16"	D02150838
10	G1/4	40,5	10	20,5	8	6,5	11/16"	D02151028
10	G3/8	39,5	9	26,5	8	6,5	13/16"	D02151038
10	G1/2	44	13,5	29	8,1	6,7	1"	D02151048
12	G3/8	43,5	10	26,5	8,1	9,5	13/16"	D02151238
12	G1/2	47	13,5	29	8,1	9,5	1"	D02151248

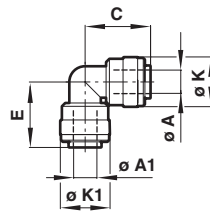
**Union elbow  
D0040**

Ø A	Ø A1	C	E	Ø K	Ø K1	Model
4	4	17,5	17,5	13	13	D00400400
5	5	17,5	17,5	13	13	D00400500
6	6	20	20	15	15	D00400600
8	4	21	21	18	13	D00400804
8	5	21	21	18	13	D00400805
8	6	21	21	17,5	17,5	D00400806
8	8	21	21	17,5	17,5	D00400800
10	6	23,5	23,5	19,5	15	D00401006
10	8	25,5	25	19,5	19,5	D00401008
10	10	25,5	25,5	19,5	19,5	D00401000
12	6	25,5	25	9,5	19,5	D00401206
12	8	25,5	25,5	19,5	19,5	D00401208
12	10	31	30	22,5	22,75	D00401210
12	12	31	31	22,5	22,5	D00401200

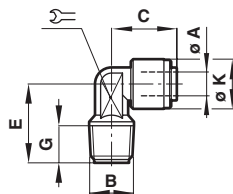
**Elbow adaptor  
D0145**

Ø A	B	C	E	G	Ø K	Symbol	Model
6	R1/8	19,5	20	10	15	3/8"	D01450618
6	R1/4	24,5	24	11	15	3/8"	D01450628
6	R3/8	19,5	22	12	15	3/8"	D01450638
8	R1/4	25	23,5	11	20	9/16"	D01450828
8	R3/8	25	24	12	20	9/16"	D01450838
10	R1/4	25	24	11	20	9/16"	D01451028
10	R3/8	25	24	12	20	9/16"	D01451038
12	R3/8	31	30	12	23	11/16"	D01451238
12	R1/2	31	31,5	16	23	11/16"	D01451248

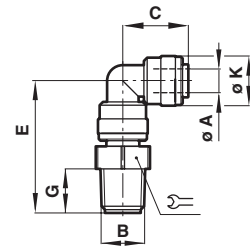
**90° Swivel elbow adaptor  
D0147**

Ø A	B	C	E	G	Ø K	Symbol	Model
4	R1/8	16,5	30,5	10	13	9/16"	D01470418
4	R1/4	16,5	30,5	13,5	13	11/16"	D01470428
5	R1/8	17	30,5	10	13	9/16"	D01470518
6	R1/8	20	34,5	10	15	9/16"	D01470618
6	R1/4	20	34	13,5	15	11/16"	D01470628
8	R1/8	21,5	36,5	10	17,5	9/16"	D01470818
8	R1/4	21,5	36,5	13,5	17,5	11/16"	D01470828
8	R3/8	21,5	36,5	14	17,5	13/16"	D01470838
10	R1/4	25,5	42	13,5	19,5	11/16"	D01471028
10	R3/8	25,5	42	14	19,5	13/16"	D01471038
12	R3/8	31	49	14	22,5	13/16"	D01471238
12	R1/2	31	49	19	22,5	1"	D01471248

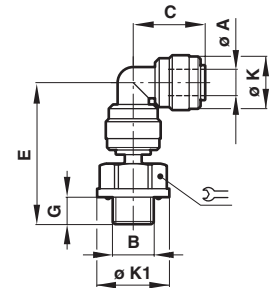
**90° Swivel elbow adaptor (BSPP)  
D0247**

Ø A	B	C	E	G	Ø K	Ø K1	Symbol	Model
4	G1/8	16,5	33,5	6,5	13	17	9/16"	D02470418
4	G1/4	16,5	37	10	13	20,5	11/16"	D02470428
5	G1/8	17,5	34	6,5	13	17	9/16"	D02470518
5	G1/4	17,5	37,5	10	13	20,5	11/16"	D02470528
6	G1/8	19,5	36,5	6,5	15	17	9/16"	D02470618
6	G1/4	19,5	40	10	15	20,5	11/16"	D02470628
8	G1/8	21	37,5	6,5	18	17	13/16"	D02470818
8	G1/4	20	41	10	18	20,5	1"	D02470828
8	G3/8	21	40,5	10	18	26	13/16"	D02470838
10	G1/4	25,5	45,5	10	20	20,5	11/16"	D02471028
10	G3/8	25,5	45,5	10	20	26	13/16"	D02471038
10	G1/2	25,5	49	13,5	20	29	1"	D02471048
12	G3/8	31	51	10	24	26	13/16"	D02471238
12	G1/2	31	54,5	13,5	24	29	1"	D02471248

**45° Elbow adaptor  
D005A**

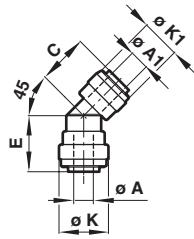

Ø A	Ø A1	C	E	Ø K	Ø K1	Model
10	6	20,5	21,5	20	15	D005A1006
12	8	22,5	25	23	17,5	D005A1208

**Stem elbow  
D0043**

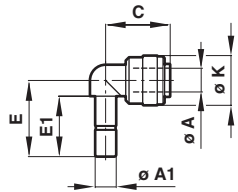

Ø A	Ø A1	C	E	E1	Ø K	Model
4	4	17,5	21	15,5	13	D00430400
5	5	17,5	21	15,5	13	D00430500
6	6	19,5	23	18,5	15	D00430600
6	10	21	31	25	17,5	D00431006
8	8	21	31	25	17,5	D00430800
8	10	21	31	25	17,5	D00431008
10	10	25,5	36,5	25	20	D00431000
12	12	29,5	34,5	25,5	23	D00431200

**Union tee  
D0060**

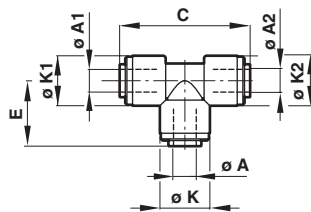

Ø A	Ø A1	Ø A2	C	E	Ø K	Ø K1	Ø K2	Model
4	4	4	35	17,5	13	13	13	D00600400
5	5	5	35	17,5	13	13	13	D00600500
6	6	6	39	19,5	15	15	15	D00600600
8	8	8	42	21	17,5	17,5	17,5	D00600800
10	10	10	50	25	19,5	19,5	19,5	D00601000
12	12	12	60	30	23	23	23	D00601200

**D006A Union tee (reducing)**

Ø A	Ø A1	Ø A2	C	E	Ø K	Ø K1	Ø K2	Model
6	10	10	50	24	15	19,5	19,5	D006A1006
10	12	12	60	29	19,5	23	23	D006A1210

**D006B Union tee (reducing)**

Ø A	Ø A1	Ø A2	C	E	Ø K	Ø K1	Ø K2	Model
12	12	10	59,5	30,5	23	23	19,5	D006B1210

**Swivel tee adaptor  
D0167**

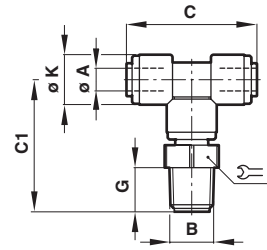

Ø A	B	C	C1	G	Ø K	⌀	Model
4	R1/8	34,5	34	10	13	9/16"	D01670418
4	R1/4	34,5	37,5	13	13	11/16"	D01670428
5	R1/8	34,5	34	10	13	9/16"	D01670518
5	R1/4	34,5	39	13	13	11/16"	D01670528
6	R1/8	39,5	36,5	10	15	9/16"	D01670618
6	R1/4	39,5	40	13	15	11/16"	D01670628
8	R1/8	41,5	37,5	10	18	9/16"	D01670818
8	R1/4	41,5	41	13	18	11/16"	D01670828
8	R3/8	41,5	41,5	14	18	13/16"	D01670838
10	R1/4	50	45	13	20	11/16"	D01671028
10	R3/8	50	45,5	14	20	13/16"	D01671038
10	R1/2	50	51,5	17,5	20	1"	D01671048
12	R3/8	60	50,5	14	23	13/16"	D01671238
12	R1/2	60	55,5	18,5	23	1"	D01671248

**Swivel side tee adaptor  
D0168**

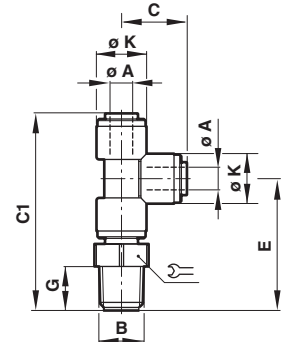

Ø A	B	C	C1	E	G	Ø K	⌀	Model
4	R1/8	16,5	51	35,5	10	13	9/16"	D01680418
4	R1/4	16,5	55	39,5	13,5	13	11/16"	D01680428
5	R1/8	10	51	14	10	13	9/16"	D01680518
5	R1/4	17	55	39,5	13,5	13	11/16"	D01680528
6	R1/8	20	56	37,5	10	15	9/16"	D01680618
6	R1/4	20	59,5	41,5	13,5	15	11/16"	D01680628
8	R1/8	21,5	58	38,5	10	17,5	9/16"	D01680818
8	R1/4	21,5	61,5	43,5	13,5	17,5	11/16"	D01680828
8	R3/8	21,5	62	43,5	14	17,5	13/16"	D01680838
10	R1/4	25	70	48	13,5	19,5	11/16"	D01681028
10	R3/8	25	71	48,5	14	19,5	13/16"	D01681038
12	R3/8	30	80,5	53,5	14	23	13/16"	D01681238
12	R1/2	30	85	58	19	23	1"	D01681248

**Swivel tee adaptor  
D0267**

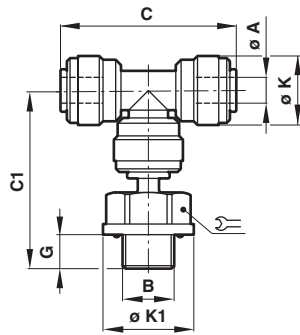

Ø A	B	C	C1	G	Ø K	Ø K1	↺	Model
4	G1/8	27	33	6,5	13	17	9/16"	D02670418
4	G1/4	27	37	10	13	20,5	11/16"	D02670428
5	G1/8	27,5	34	6,5	13	17	9/16"	D02670518
5	G1/4	27,5	37,5	10	13	20,5	11/16"	D02670528
6	G1/8	32	35,5	6,5	15	17	9/16"	D02670618
6	G1/4	32	39	10	15	20,5	11/16"	D02670628
8	G1/8	33,5	37	6,5	18	17	13/16"	D02670818
8	G1/4	33,5	40,5	10	18	20,5	1"	D02670828
8	G3/8	33,5	40,5	10	18	26	13/16"	D02670838
10	G1/4	40,5	47	10	20	20,5	11/16"	D02671028
10	G3/8	40,5	47	10	20	26	13/16"	D02671038
10	G1/2	40,5	50,5	13,5	20	29	1"	D02671048
12	G3/8	49	49	10	24	26	13/16"	D02671238
12	G1/2	49	51,5	13,5	24	29	1"	D02671248

**Union Y  
D0082**

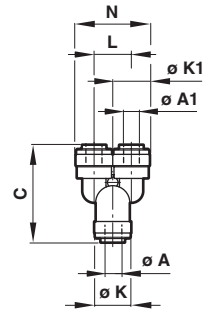

Ø A	Ø A1	C	Ø K	Ø K1	L	N	Model
4	4	39	13	13	12,5	30	D00820400
6	6	39	15	15	15	30	D00820600
8	8	43,5	17,5	17,5	17	34,5	D00820800
10	8	48,5	20	17,5	17	39,5	D00821008
10	10	48,5	20	20	20	39,5	D00821000
12	12	56,5	23	23	23	46	D00821200

**U bend  
D0089**

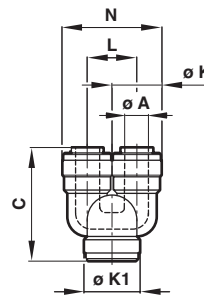

Ø A	C	Ø K	Ø K1	L	N	Model
6	34,5	15	17	15	30	D00890600
8	36,5	17,5	19,5	17	34,5	D00890800
10	40,5	20	22	19,5	39,5	D00891000
12	47,5	23	25	22,5	45,5	D00891200

**Swivel side tee adaptor  
D0268**

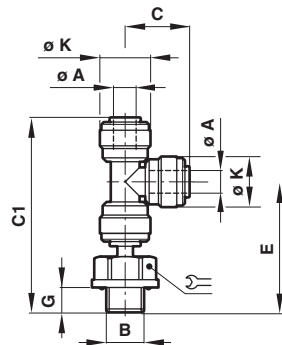

Ø A	B	C	C1	E	G	Ø K	↺	Model
4	G1/8	17	50	43,5	6,5	13	9/16"	D02680418
4	G1/4	17	53,5	47	10	13	11/16"	D02680428
5	G1/8	17,5	51	44,5	6,5	13	9/16"	D02680518
5	G1/4	17,5	54,5	48	10	13	11/16"	D02680528
6	G1/8	20	55,5	48	6,5	15	9/16"	D02680618
6	G1/4	20	59	51,5	10	15	11/16"	D02680628
8	G1/8	21	62,5	50	6,5	17,5	13/16"	D02680818
8	G1/4	21	62,5	53,5	10	17,5	1"	D02680828
8	G3/8	21	62	53	10	17,5	13/16"	D02680838
10	G1/4	25,5	71,5	61,5	10	20,5	11/16"	D02681028
10	G3/8	25,5	71	61	10	20,5	13/16"	D02681038
10	G1/2	25,5	74,5	64,5	13,5	20,5	1"	D02681048
12	G3/8	30	81,5	69,5	10	23,5	13/16"	D02681238
12	G1/2	30	81,5	73	13,5	23,5	1"	D02681248

**Union cross  
D0090**

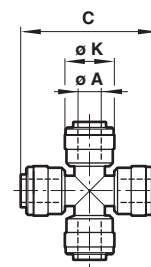

Ø A	C	Ø K	Model
4	33	13	D00900400
6	42	15	D00900600
8	42,5	17,5	D00900800
10	50,5	20	D00901000
12	58,5	23	D00901200

**3 way splitter  
D0091**

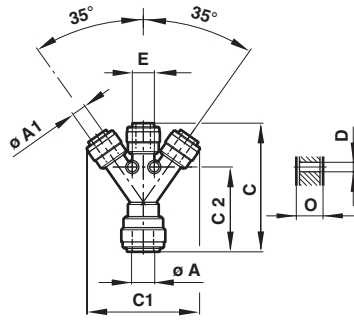

Ø A	Ø A1	C	C1	C2	D	E	Ø K	Model
10	6	58,5	51,5	38,5	4,3	10	0,85	D00911006
12	10	71,5	67	48	4,3	14	0,85	D00911210

**Check valve  
D00GL**

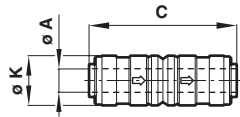

Ø A	C	Ø K	Model
6	45,5	15	D00GL0600
8	47,5	17,5	D00GL0800
10	53	20	D00GL1000
12	60,5	23	D00GL1200

**Shut-off valve mounting clip (for valve Ø 10 only)  
D00GM1000**

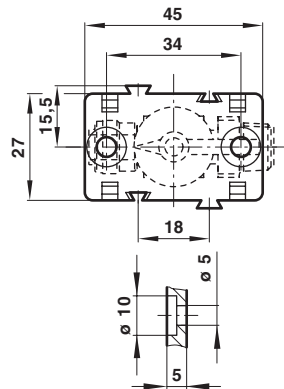

**2/2-Wege Absperrventil, Rohr/Rohr  
D00GR**

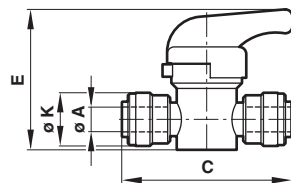

Ø A	C	E	Ø K	Model
6	48	39,5	15	D00GR0600
10	58	47	20	D00GR1000
12	66,5	45,5	23	D00GR1200

**Hand valve 2/2 shut-off (tube to tube)  
D00GR**

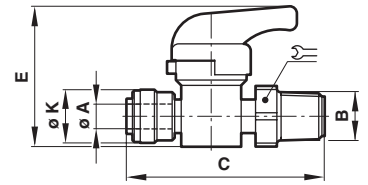

Ø A	B	C	E	Ø K	Symbol	Model
6	R1/4	57	39,5	15	11/16	D01GT0628
10	R3/8	62,5	45,5	20	3/4	D01GT1038
12	R1/2	71,5	45,5	23	1	D01GT1248

**Hand valve 2/2 shut-off (tube to male thread)  
D01GT**

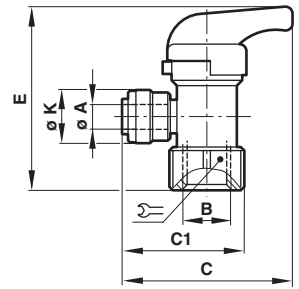

Ø A	B	C	C1	E	Ø K	Symbol	Model
6	R1/4	48	34,3	52,5	15	3/4	D01GU0628
10	R3/8	58,5	41,9	58	20	1	D01GU1038
10	R1/2	58	43	62	20	1	D01GU1048
12	R3/8	62	47	61	23	1 1/4	D01GU1238
12	R1/2	62,5	47,6	61	23	1 1/4	D01GU1248

**Plug  
D0004**

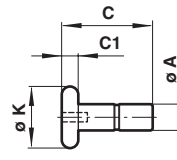

Ø A	C	C1	Ø K	Model
4	19,5	3	12,5	D00040400
5	19,5	3	12,5	D00040500
6	22	4	15	D00040600
8	23	4	17	D00040800
10	26,5	4	19	D00041000
12	30	4	21	D00041200

**Tube supports  
D0033**

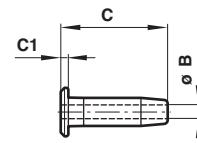

O/D	Ø B	C	C1	Model
8	6	16	1	D00330806
10	7	18	1	D00331008
12	9	21	1	D00331210

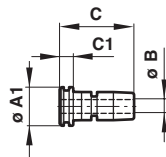

**Tube supports for double seal tube support  
D0033\*\*\*\*H**

Tube Ø	Ø A1	Ø B	C	C1	Model
8	7,5	6	16	3,5	D00330806H
10	10	7	18	3,5	D00331008H
12	12	9	21	4	D00331210H

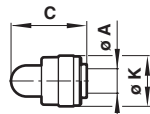
**End stop (female plug)  
D000A**

Ø A	C	Ø K	Model
6	22,5	15	D000A0600
8	23	17,5	D000A0800
10	26,5	20	D000A1000
12	32,5	23	D000A1200

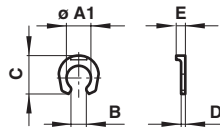
**Locking clip  
D0LC**

Tube Ø	Ø A1	B	C	D	E	Model
6	8,2	5,1	15	1,4	3	D0LC0600
12	14,5	11,1	21	2,6	4,5	D0LC1200

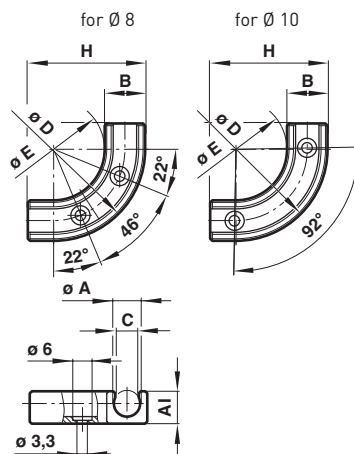
**Flow bend tube clip  
D005B**

Tube Ø	A1	B	C	Ø D	Ø E	H	Model
8	10,2	12,7	7,5	57,4	32	36,5	D005B0800
10	12,2	15,2	9	59,9	29,5	47	D005B1000

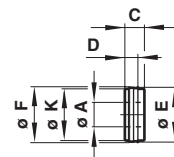
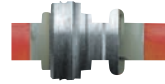
**Cartridges (brass)  
D0008\*\*\*\*B**

Ø A	C	D	Ø E	Ø F	Ø K	Model
4	4,5	3	12,6	12,4	11,9	D00080400B
5	4,5	3	12,1	11,9	11,4	D00080500B
6	4,5	3,1	13,6	13,4	12,9	D00080600B
8	5,5	3,3	13,9	13,7	13,2	D00080800B
10	7	4,3	16,2	16	15,6	D00081000B
12	7,5	4,8	19,9	19,6	19,1	D00081200B

**Cartridges (stainless steel)  
D0008\*\*\*\*G**

Ø A	C	D	Ø E	Ø F	Ø K	Model
4	4,5	3	12,6	12,4	11,9	D00080400G
5	4,5	3	12,1	11,9	11,4	D00080500G
6	4,5	3,1	13,6	13,4	12,9	D00080600G
8	5,5	3,3	13,9	13,7	13,2	D00080800G
10	7	4,3	16,2	16	15,6	D00081000G
12	7,5	4,8	19,9	19,6	19,1	D00081200G

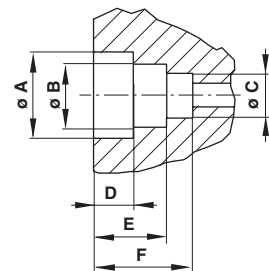
**Metric one O ring**

Tube Ø	Ø A±0.05	Ø B±0.05	Ø C±0.05	D+0.25	Ø E±0.15	Ø F±0.15
4	12,44	8,05	4,1	4,59	9,39	12,75
5	11,93	8,73	5,1	4,59	9,39	12,75
6	13,46	10,69	6,1	4,59	9,47	13,84
8	13,76	11,81	8,1	5,41	10,5	15,63
10	16	14,3	10,1	6,8	11,98	18,27
12	19,68	16,78	12,1	7,69	13,33	21

## Warning

These products are intended for use in industrial compressed air and fluid systems only. Do not use these products where pressures and temperatures can exceed those listed under »**Technical features**«.

Before using these products with fluids other than those specified, for non-industrial applications, life-support systems, or other applications not within published specifications, consult NORGREN.

Through misuse, age, or malfunction, components used in fluid power systems can fail in various modes.

The system designer is warned to consider the failure modes of all component parts used in fluid power systems and to provide adequate safeguards to prevent personal injury or damage to equipment in the event of such failure.

System designers must provide a warning to end users in the system instructional manual if protection against a failure mode cannot be adequately provided.

System designers and end users are cautioned to review specific warnings found in instruction sheets packed and shipped with these products.