

**10 series (Pneufit)  
Push-in fittings  
Ø 4 ... 14 mm O/D tube, BSP threads**

**Very compact units**

**Easy tube insertion for rapid assembly of pneumatic circuits**

**Positive tube anchorage**

**All BSP taper threads pre-coated with non-PTFE based sealant**

**Straight adaptors feature internal hexagon for allen key**

**Silicone free 'O'-rings**



**Technical features**

**Medium:**

Compressed air  
(For other media please consult Technical Department)

**Operating pressure:**

Vacuum -18 bar  
(Dependent upon operating specification of tubing)

**Vacuum:**

-750 mm of Hg i.e. 98%

**Operating temperature:**

-20°C ... +80°C  
"Special" low temperature options contact Norgren Technical service

**Tube sizes:**

4, 5, 6, 8, 10, 12, 14 mm O/D

**Tubing types:**

PA 11 or 12, PUR and other plasticised or unplasticised tubing which conforms to the tolerances specified in BS 5409, Part 1, 1976, light and normal duty, DIN 73378, DIN 74234, NFE 49-100

**Materials**

Nickel plated brass body  
Nickel plated brass for collet  
Silicone free NBR  
'O'-ring (FPM optional)  
Plastic sealing washer (parallel threads)  
Non - PTFE thread sealant (taper threads)

**Method of assembly**

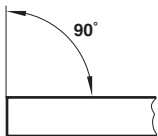

1. Ensure that the end of the tube is cut square and is free from burrs.

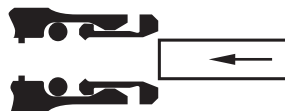

2. Push the tube through the collet into the fitting.



3. Continue pushing the tube through the 'O'-ring until it bottoms on the tube stop then pull back.

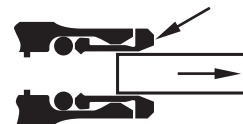

4. To disconnect push the tube into the fitting, hold down the collet and withdraw the tube.

**Components**

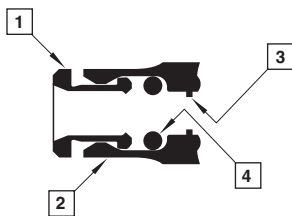





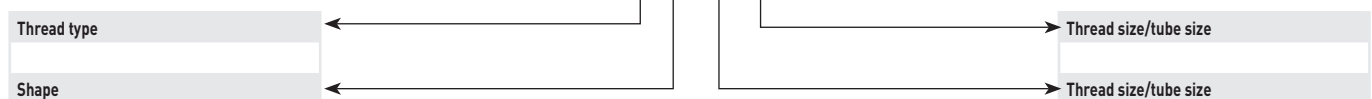

- 1 Collet
- 2 Body
- 3 Tube stop
- 4 'O'-ring





**Option selector**

10 ★★★★★★







**Straight adaptors and connectors**

<p>Stem tailpiece adaptor (stem to hose bore) 10019</p>  <p>Page 3</p>	<p>Straight connector (tube to tube) 10020</p>  <p>Page 3</p>	<p>Straight stem connector 10022</p>  <p>Page 3</p>	<p>Reducing/expanding connector 10023</p>  <p>Page 3</p>	<p>Bulkhead connector (tube to tube) 10029</p>  <p>Page 4</p>	<p>Mixed bulkhead connector 10031</p>  <p>Page 4</p>	<p>Straight stem adaptor (BSP taper) 10115</p>  <p>Page 4</p>
---	--	--	---	---	---	--







<p>Straight stem adaptor (BSP parallel) 10215</p>  <p>Page 4</p>	<p>Straight adaptor (BSP taper) 10125</p>  <p>Page 5</p>	<p>Straight adaptor (BSP parallel) 10225</p>  <p>Page 5</p>	<p>Female straight adaptor (female parallel BSP) 10226</p>  <p>Page 5</p>
---	---	--	--

**Elbow adaptors, connectors and banjos**

<p>Elbow connector 10040</p>  <p>Page 6</p>	<p>Stem elbow connector 10043</p>  <p>Page 6</p>	<p>Bulkhead swivel elbow connector 10049</p>  <p>Page 6</p>	<p>Elbow adaptor (BSP taper) 10145</p>  <p>Page 6</p>	<p>90° Swivel elbow adaptor (BSP taper) 10147</p>  <p>Page 7</p>	<p>90° Swivel elbow adaptor (BSP parallel) 10247</p>  <p>Page 7</p>	<p>Extended swivel elbow adaptor (BSP taper) 10154</p>  <p>Page 7</p>
--	---	--	--	--	--	--

<p>45° Swivel elbow adaptor (BSP parallel) 10257</p>  <p>Page 7</p>	<p>Elbow banjo assembly (non-Regulating BSP parallel) 10A51</p>  <p>Page 8</p>	<p>Elbow banjo assembly (regulating-out BSP parallel) 10K51</p>  <p>Page 8</p>	<p>Elbow banjo assembly (regulating-out BSPT taper) 10T00</p>  <p>Page 8</p>	<p>Elbow banjo assembly (regulating-out BSPT taper) 10TA0</p>  <p>Page 8</p>
--	---	---	---	--

**Tee adaptors, connectors and banjos, 'Y' adaptors and connectors, 4-way connectors, manifolds**

<p>Tee connector (tube x 3) 10060</p>  <p>Page 9</p>	<p>Tee adaptor (BSP taper) 10165</p>  <p>Page 9</p>	<p>Swivel tee adaptor (BSP taper) 10167</p>  <p>Page 9</p>	<p>Swivel tee adaptor (BSP parallel) 10267</p>  <p>Page 9</p>	<p>Tee banjo assembly (non-regulating parallel thread) 10A71</p>  <p>Page 10</p>	<p>Fixed side tee adaptor (BSP taper) 10175</p>  <p>Page 10</p>	<p>Swivel tee adaptor (BSP taper) 10168</p>  <p>Page 10</p>
---	--	---	--	--	--	--

<p>Swivel tee adaptor (BSP parallel) 10268</p>  <p>Page 10</p>	<p>4-way connector (tube x 4) 10090</p>  <p>Page 11</p>	<p>Parallel Y-connector 10082</p>  <p>Page 11</p>	<p>Parallel Y-adaptor 10188</p>  <p>Page 11</p>	<p>Parallel Y-adaptor 10288</p>  <p>Page 11</p>	<p>Manifold 100D6</p>  <p>Page 12</p>	<p>Manifold 101D6</p>  <p>Page 12</p>
---	--	--	--	---	--	--

**Banjo bodies and bolts**

<p>Elbow banjo body 10051</p>  <p>Page 13</p>	<p>Tee banjo body 10071</p>  <p>Page 13</p>	<p>Banjo bolt (non-regulating single stacking) 20A00</p>  <p>Page 13</p>	<p>Banjo bolt (non-regulating double stacking BSP parallel) 20B00</p>  <p>Page 13</p>	<p>Banjo bolt (non-regulating triple stacking BSP parallel) 20C00</p>  <p>Page 13</p>	<p>Banjo bolt (non-regulating single stacking, top port BSP parallel) 20*00</p>  <p>Page 13</p>	<p>Banjo bolt (regulating single stacking) 20*00</p>  <p>Page 13/14</p>
--	--	---	--	---	--	--

**Accessories**

 Silencer (plug in)  
10011



Page 14

 Plug (acetal)  
11004

Page 14

**Technical data**

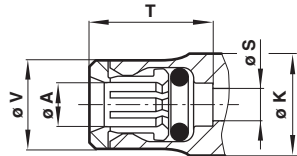
Ø A O/D tube	Ø S*2)	Ø T*1)	V	Ø K
4	2,8	14	7,5	10
5	3,4	15	10	11
6	4,4	15,5	11	12
8	6	16,5	13	14
10	7,6	21	14,5	17
12	9,6	24,5	18	20,5
14	11,5	24,5	20	21



\*1) Dimensions here and in the individual tables refer to the collet being in the 'IN' position.

\*2) Dimensions here (minimum bore diameter) are common per tube size for all Connectors, elbows and Tees unless otherwise stated.

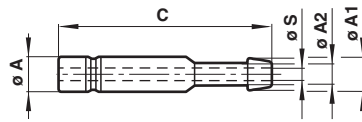
**Stem tailpiece adaptor, stem to hose bore  
10019**

Ø A	Ø A1	Ø A2	C	Ø S	Model
4	4,5	3	34	1,8	100190403
4	6,5	5	34	2,1	100190405
5	6,5	5	35,5	2,8	100190505
6	6,5	5	36	2,8	100190605
6	8	6,5	36	4	100190606
8	8	6,5	37	4,3	100190806
8	9,5	8	38,5	5,5	100190808
10	8	6,5	41,5	4,3	100191006
10	9,5	8	43	5,5	100191008
10	12	10	44	7,3	100191010
12	9,5	8	46,5	5,5	100191208
12	12	10	46,5	7,3	100191210
12	15	12,5	47,5	9,7	100191212
14	15	12,5	47	9,7	100191412

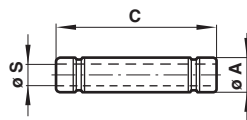
**Straight stem connector  
10022**

Ø A	C	Ø S	Model
4	30	2,6	100220400
5	33	3,4	100220500
6	34	4	100220600
8	36	6	100220800
10	45	7,6	100221000
12	52	9,6	100221200
14	52	11,5	100221400

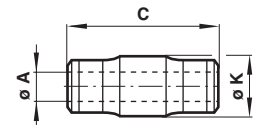
**Straight connector, tube to tube  
10020**

Ø A	C	Ø K	Model
4	30	10	100200400
5	32	11	100200500
6	33,5	12	100200600
8	35,5	14	100200800
10	44,5	17	100201000
12	51,5	20,5	100201200
14	52,5	21	100201400

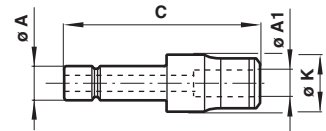
**Reducing/expanding connector  
10023**

Ø A	Ø A1	C	Ø K	Model
5	4	33,5	10	100230504
6	4	34	10	100230604
6	5	35	11	100230605
8	4	31	10	100230804
8	5	33	11	100230805
8	6	36,5	12	100230806
10	4	31	12	100231004
10	5	36,5	12	100231005
10	6	37,5	12	100231006
10	8	38	14	100231008
12	4	35	14	100231204
12	5	35	14	100231205
12	6	35	14	100231206
12	8	42	14	100231208
12	10	50	17	100231210
14	6	36,5	16	100231406
14	8	37,5	16	100231408
14	10	46,5	17	100231410
14	12	53,5	20,5	100231412

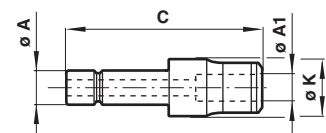
**Reducing/expanding connector  
10023**

Ø A	Ø A1	C	Ø K	Model
4	6	35	12	100230406
6	8	37,5	14	100230608

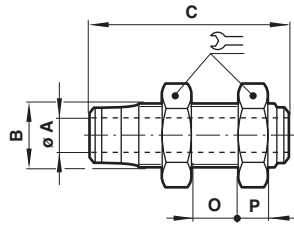
**Bulkhead connector, tube to tube  
10029**

Ø A	B	C	O	P		Model
4	M10x1,0	30	12	9	14	100290400
5	M12x1,0	32	14	9	17	100290500
6	M14x1,5	35,5	15	10	19	100290600
8	M16x1,5	36,5	16	10	22	100290800
10	M20x1,5	43,5	14	11	27	100291000
12	M24x1,5	50,5	15	11	30	100291200
14	M24x1,5	50,5	15	11	30	100291400

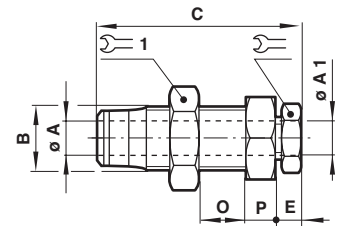
**Mixed bulkhead connector  
10031**

Ø A & Ø A1	B	C	E	O	P			Model
4	M12x1,0	27	6	9,5	9	8	17	100310404
6	M15x1,0	29,5	7	9,5	10	13	22	100310606
8	M18x1,5	33,5	8	11	10	13	24	100310808
10	M20x1,5	40	8	14,5	11	17	27	100311010
12	M24x1,5	44	9	17,5	11	19	30	100311212
14	M26x1,5	46	11,5	18,5	11	22	32	100311414

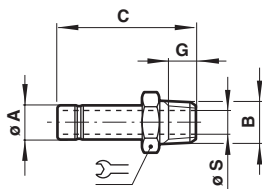
**Straight stem adaptor, BSP taper  
10115**

Ø A	B	C	G	Ø S		Model
4	R1/8	30	7,5	2,1	10	101150418
4	R1/4	33,5	11	2,1	14	101150428
5	R1/8	31	7,5	3,2	11	101150518
5	R1/4	35	11	3,2	14	101150528
6	R1/8	32	7,5	4,1	12	101150618
6	R1/4	35	11	4,1	14	101150628
8	R1/8	33	7,5	7,1	14	101150818
8	R1/4	36,5	11	5,1	14	101150828
8	R3/8	40	12,5	5,1	19	101150838
10	R1/4	40	11	7,7	15	101151028
10	R3/8	45	12,5	7,7	19	101151038
10	R1/2	48	16	8,1	22	101151048
12	R3/8	48	12,5	9,1	19	101151238
12	R1/2	51,5	16	9,1	22	101151248
14	R1/2	51,5	16	11,2	22	101151448

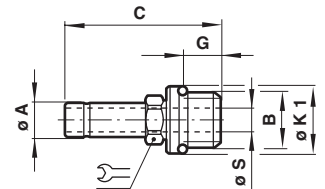
**Straight stem adaptor, BSP parallel  
10215**

Ø A	B	C	G	Ø K1	Ø S		Model
4	G1/8	29	5	13,5	2,1	8	102150418
4	G1/4	33	7,5	17,5	2,1	10	102150428
5	G1/8	30,5	5	13,5	3,3	8	102150518
5	G1/4	34	7,5	17,5	3,3	10	102150528
6	G1/8	31	5	13,5	4	8	102150618
6	G1/4	34,5	7,5	17,5	4	10	102150628
8	G1/8	32,5	5	13,5	5	10	102150818
8	G1/4	35,5	7,5	17,5	6	10	102150828
8	G3/8	39	9	21,5	6	13	102150838
10	G1/4	41,5	7,5	17,5	6,5	13	102151028
10	G3/8	43,5	9	21,5	8	13	102151038
10	G1/2	49	12	25,5	8	17	102151048
12	G3/8	48,5	9	21,5	10	17	102151238
12	G1/2	52,5	12	25,5	10	17	102151248
14	G3/8	48,5	9	21,5	10	17	102151438
14	G1/2	52,5	12	25,5	11,5	17	102151448

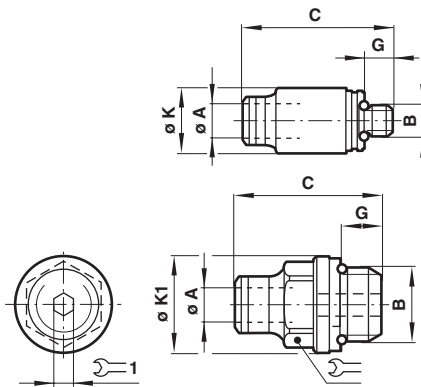
**Straight adaptor, BSP parallel  
10225**

Ø A	B	C	G	Ø K	Ø K1			Model
4	M3	21	2,5	9	-	-	1,5	102250403
4	M5	21,5	3,5	9	-	-	2,5	102250405
4	G1/8	19	5,5	-	14	10	3	102250418
4	G1/4	21	8	-	18	10	3	102250428
5	M5	23	3,5	10	-	-	2,5	102250505
5	G1/8	23,5	5,5	-	14	10	4	102250518
5	G1/4	22,5	8	-	18	12	4	102250528
6	M5	24	3,5	11	-	-	2,5	102250605
6	G1/8	25	5,5	-	14	11	4	102250618
6	G1/4	23,5	8	-	18	13	4	102250628
8	G1/8	26,5	5,5	-	14	13	5	102250818
8	G1/4	28	8	-	18	14	6	102250828
8	G3/8	24,5	9	-	12	17	6	102250838
8	G1/2	28,5	11	-	26	17	6	102250848
10	G1/8	32	5,5	-	14	17	5	102251018
10	G1/4	33,5	8	-	18	17	7	102251028
10	G3/8	32,5	9	-	22	19	8	102251038
10	G1/2	30,5	11	-	26	19	8	102251048
12	G1/4	36,5	8	-	18	22	7	102251228
12	G3/8	37,5	9	-	22	22	10	102251238
12	G1/2	34,5	11	-	26	22	10	102251248
14	G3/8	37,5	9	-	22	22	10	102251438
14	G1/2	38,5	11	-	26	22	10	102251448

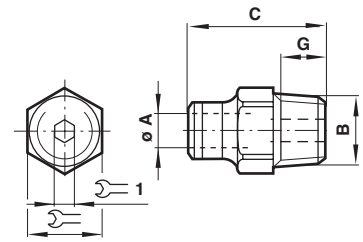
**Straight adaptor, BSP taper  
10125**

Ø A	B	C	G			Model
4	R1/8	20,5	10	10	3	101250418
4	R1/4	23	11	14	3	101250428
5	R1/8	22,5	7,5	10	4	101250518
5	R1/4	23	11	14	4	101250528
6	R1/8	23	7,5	11	4	101250618
6	R1/4	25	11	14	4	101250628
8	R1/8	26,5	7,5	13	5	101250818
8	R1/4	28	11	14	6	101250828
8	R3/8	27	12,5	17	6	101250838
8	R1/2	29	16	22	6	101250848
10	R1/8	31,5	7,5	17	5	101251018
10	R1/4	34	11	17	7	101251028
10	R3/8	34	12,5	17	8	101251038
10	R1/2	33,5	16	22	8	101251048
12	R1/4	39	11	22	7	101251228
12	R3/8	39	12,5	22	10	101251238
12	R1/2	40	16	22	10	101251248
14	R3/8	39,5	12,5	22	10	101251438
14	R1/2	40	16	22	10	101251448

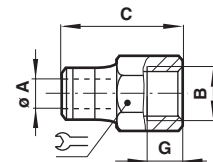
**Female straight adaptor, female parallel BSP  
10226**

Ø A	B	C	G		Model
4	M5	22,5	5	10	102260405
4	G1/8	24,5	7,5	13	102260418
4	G1/4	29	5	17	102260428
5	M5	23,5	7,5	10	102260505
5	G1/8	25,5	7,5	13	102260518
5	G1/4	29,5	7,5	17	102260528
6	G1/8	26	11	13	102260618
6	G1/4	30,5	11	17	102260628
8	G1/8	27	11	13	102260818
8	G1/4	31,5	11	17	102260828
10	G1/4	36,5	11	17	102261028
10	G3/8	39	11,5	19	102261038
12	G3/8	41	11,5	19	102261238
12	G1/2	44,5	15	24	102261248

**Elbow connector  
10040**

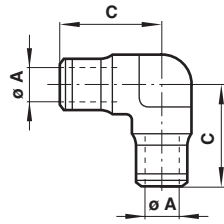

$\varnothing A$	C	Model
4	17	100400400
5	18,5	100400500
6	19,5	100400600
8	21,5	100400800
10	26,5	100401000
12	31,5	100401200
14	33	100401400

**Stem elbow connector  
10043**

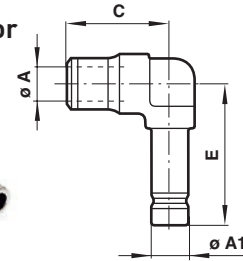

$\varnothing A$	$\varnothing A1$	C	E	Model
4	4	9,5	25	100430400
6	6	19	27,5	100430600
8	8	21	29,5	100430800
8	5	19,5	30	100430805

**Bulkhead swivel elbow connector  
10049**

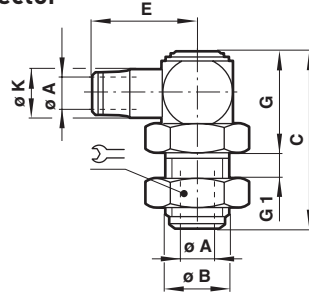

$\varnothing A$	$\varnothing B$	C	E	G	G1	$\varnothing K$		Model
4	M12x1,0	35,5	20,5	21,5	7	10	17	100490400
5	M12x1,0	35,5	21,5	21,5	7	11	17	100490500
6	M14x1,5	40	24	24,5	7	12	19	100490600
8	M16x1,5	45	26,5	30	7	14,5	22	100490800
10	M22x1,5	49	31,5	31	9	17	27	100491000
12	M24x1,5	54	38	32,5	12	20,5	30	100491200
14	M26x1,5	57	38	32,5	15	22,5	32	100491400

**Elbow adaptor, BSP taper  
10145**

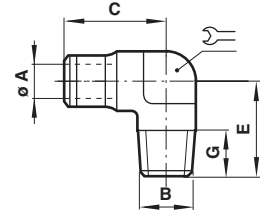

$\varnothing A$	B	C	E	G		Model
4	R1/8	15	17	7,5	7	101450418
4	R1/4	20	18	11	11	101450428
5	R1/8	15,5	18,5	7,5	7	101450518
5	R1/4	20	20	11	11	101450528
6	R1/8	16	19,5	7,5	8	101450618
6	R1/4	20	20	11	11	101450628
8	R1/8	17	21,5	7,5	11	101450818
8	R1/4	20	21,5	11	11	101450828
8	R3/8	23	22	12,5	13	101450838
8	R1/2	29	24	16	17	101450848
10	R1/8	18,5	26,5	7,5	13	101451018
10	R1/4	21,5	26,5	11	13	101451028
10	R3/8	23	26,5	12,5	13	101451038
10	R1/2	29	28,5	16	17	101451048
12	R1/4	23,5	31,5	11	16	101451228
12	R3/8	25	31,5	12,5	16	101451238
12	R1/2	29	32	16	17	101451248

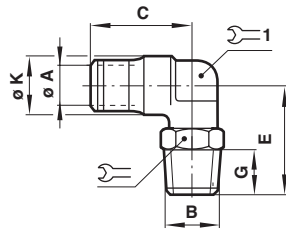
**90° Swivel elbow adaptor, BSP taper  
10147**

Ø A	B	C	E	G	Ø K			Model
4	R1/8	17	20,5	7,5	10	10	7	101470418
4	R1/4	17	24	11	10	14	7	101470428
5	R1/8	18,5	21	7,5	11	11	9	101470518
5	R1/4	18,5	24,5	11	11	14	9	101470528
6	R1/8	19,5	21,5	7,5	12	11	9	101470618
6	R1/4	19,5	25	11	12	14	9	101470628
6	R3/8	20	27,5	12,5	12	17	8	101470638
8	R1/8	21,5	23	7,5	14,5	14	11	101470818
8	R1/4	21,5	26	11	14,5	14	11	101470828
8	R3/8	22	30,5	12,5	14,5	17	13	101470838
8	R1/2	22	34,5	16	14,5	22	13	101470848
10	R1/8	26,5	25,5	7,5	17	14	13	101471018
10	R1/4	26,5	29	11	17	17	13	101471028
10	R3/8	26,5	30,5	12,5	17	17	13	101471038
10	R1/2	26,5	34,5	16	17	22	13	101471048
12	R1/4	31,5	32	11	20,5	19	16	101471228
12	R3/8	31,5	34	12,5	20,5	22	16	101471238
12	R1/2	31,5	38	16	20,5	22	16	101471248
14	R3/8	30,5	33	12,5	21,5	22	17	101471438
14	R1/2	31,5	37	16	21,5	22	17	101471448

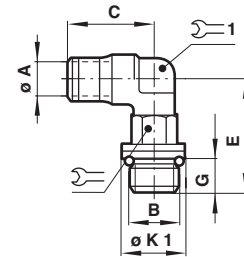
**90° Swivel elbow adaptor,  
BSP parallel  
10247**

Ø A	B	C	E	G	Ø K 1			Model
4	M3	17	17,5	3,5	-	8	7	102470403
4	M5	17	21,5	4	8	8	7	102470405
4	G1/8	17	22	5,5	14	11	7	102470418
4	G1/4	17	25,5	8	18	11	7	102470428
5	M5	18,5	20	4	8	8	9	102470505
5	G1/8	18,5	22,5	5,5	14	11	9	102470518
5	G1/4	18,5	26	8	18	11	9	102470528
6	M5	19,5	20,5	4	8	8	9	102470605
6	G1/8	19,5	23	5,5	14	11	9	102470618
6	G1/4	19,5	26,5	8	18	11	9	102470628
8	G1/8	21,5	24	5,5	14	13	11	102470818
8	G1/4	21,5	29	8	18	17	11	102470828
8	G3/8	22	33,5	9	22	19	13	102470838
8	G1/2	22	39,5	11	26	19	13	102470848
10	G1/8	26,5	26,5	5,5	14	17	13	102471018
10	G1/4	26,5	31,5	8	18	17	13	102471028
10	G3/8	26,5	33,5	9	22	19	13	102471038
10	G1/2	26,5	39,5	11	26	19	13	102471048
12	G1/4	31,5	35,5	8	18	19	16	102471228
12	G3/8	31,5	37	9	22	19	16	102471238
12	G1/2	31,5	43	11	26	19	16	102471248
14	G3/8	30,5	36	9	22	19	17	102471438
14	G1/2	31,5	39	11	26	24	17	102471448

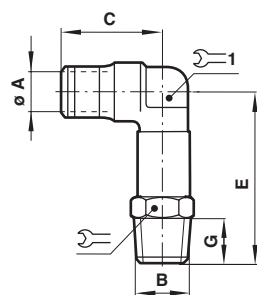
**Extended swivel elbow adaptor, BSP taper  
10154**

Ø A	B	C	E	G			Model
4	R1/8	17	34	7,5	10	7	101540418
4	R1/4	17	40	11	14	7	101540428
6	R1/8	19,5	36,5	7,5	11	9	101540618
6	R1/4	19,5	41	11	14	9	101540628
8	R1/8	21,5	40,5	7,5	14	11	101540818
8	R1/4	21,5	44,5	11	14	11	101540828
8	R3/8	22	51,5	12,5	17	13	101540838
10	R3/8	26,5	51,5	12,5	17	13	101541038

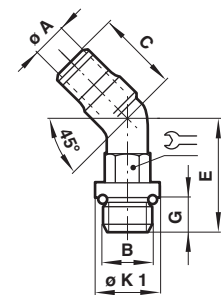
**45° Swivel elbow adaptor, BSP parallel  
10257**

Ø A	B	C	E	G	Ø K 1		Model
6	G1/8	17,5	19,5	5	14	11	102570618
6	G1/4	17,5	23	7,5	18	11	102570628
8	G1/8	19,5	20,5	5	14	11	102570818
8	G1/4	19,5	26	7,5	18	17	102570828

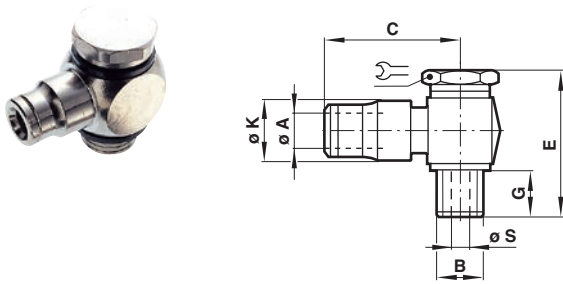
**Elbow banjo assembly,  
non-regulating BSP parallel  
10A51**

Ø A	B	C	E	G	Ø K	Ø S	⌀	Model
4	M5	18,5	22	4	9,5	2,5	8	10A510405
4	G1/8	20,5	30	6	11	5	14	10A510418
5	M5	20	22	4	11	2,5	8	10A510505
5	G1/8	21,5	30	6	11,5	5	14	10A510518
6	G1/8	23,5	30	6	12,5	5	14	10A510618
6	G1/4	24	34	7,5	13	8,5	17	10A510628
8	G1/8	23,5	30	6	14	5	14	10A510818
8	G1/4	24,5	34	7,5	14	8,5	17	10A510828
8	G3/8	26,5	41	9	16,5	10	22	10A510838
10	G1/4	30	34	7,5	16	8,5	17	10A511028
10	G3/8	31	41	9	17	10	22	10A511038

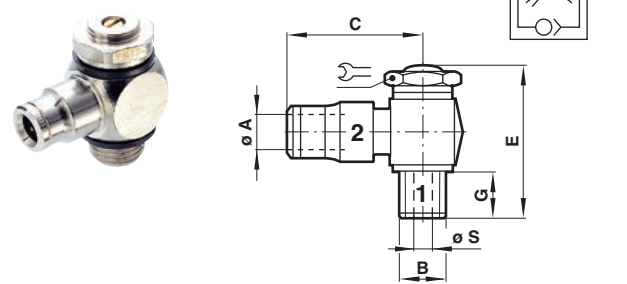
**Elbow banjo assembly,  
regulating-out BSP parallel  
10K51**

Ø A	B	C	E	G	Ø S	⌀	Model
4	M5	18,5	27	4,5	2,5	8	10K510405
4	G1/8	20,5	34	6	5	14	10K510418
5	M5	20	27	4,5	2,5	8	10K510505
5	G1/8	21,5	34	6	5	14	10K510518
6	M5	22	27	4,5	2,5	8	10K510605
6	G1/8	23,5	34	6	5	14	10K510618
6	G1/4	24	36,5	6	8,5	17	10K510628
8	G1/8	23,5	34	6	5	14	10K510818
8	G1/4	24,5	36,5	6	8,5	17	10K510828
8	G3/8	26,5	51,5	10	10	22	10K510838
10	G1/4	30	36,5	6	8,5	17	10K511028
10	G3/8	31	51,5	10	10	22	10K511038
12	G3/8	33	51,5	10	10	22	10K511238
12	G1/2	38	57,5	10	10	27	10K511248

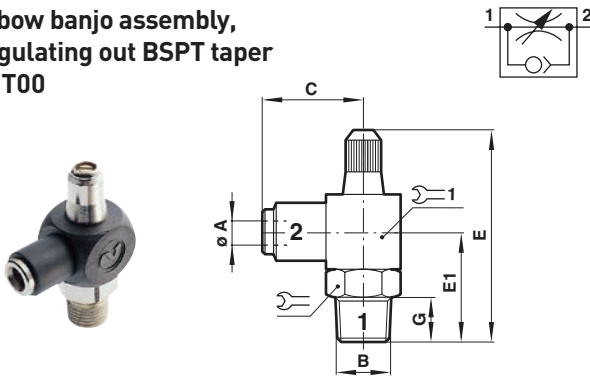
**Elbow banjo assembly,  
regulating out BSPT taper  
10T00**

Ø A	B	C	E/E1	G	⌀	⌀ 1	Model
4	R1/8	22	42/22,5	9,5	14	16	10T000418
6	R1/8	23	42/22,5	9,5	14	16	10T000618
6	R1/4	25,5	54/29,5	13,5	17	20	10T000628
8	R1/8	24,5	42/22,5	9,5	14	16	10T000818
8	R1/4	27	54/29,5	13,5	17	20	10T000828
8	R3/8	28	64/33	14,5	19	22	10T000838
10	R1/4	31,5	54/29,5	13,5	17	20	10T001028
10	R3/8	32,5	64/33	14,5	19	22	10T001038
12	R1/2	38	72/41,5	16	22	28	10T001248

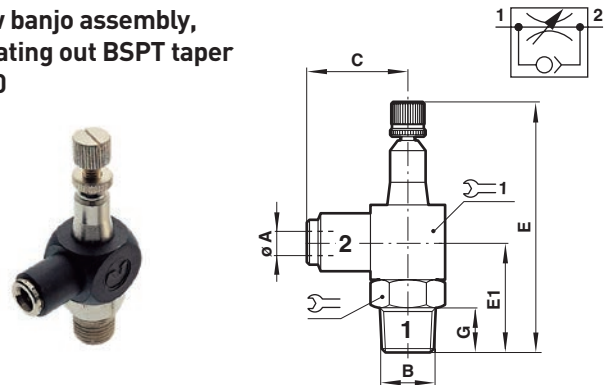
**Elbow banjo assembly,  
regulating out BSPT taper  
10TA0**

Ø A	B	C	E/E1	G	⌀	⌀ 1	Model
4	R1/8	22	53/22,5	9,5	14	16	10TA00418
6	R1/8	23	53/22,5	9,5	14	16	10TA00618
6	R1/4	25,5	67/29,5	13,5	17	20	10TA00628
8	R1/4	27	67/29,5	14,5	17	20	10TA00828
8	R3/8	28	78/33	14,5	19	22	10TA00838
10	R1/4	31,5	67/29,5	13,5	17	20	10TA01028
10	R3/8	32,5	78/33	14,5	19	22	10TA01038
12	R1/2	38	90/41,5	16	22	28	10TA01248

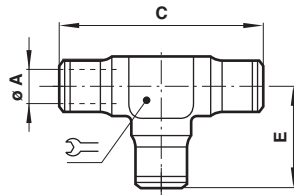

**Tee connector, tube x 3  
10060**

Ø A	C	E		Model
4	34	17	7	100600400
5	37	18,5	7	100600500
6	39	19,5	8	100600600
8	42,5	21,5	11	100600800
10	53,5	26,5	13	100601000
12	63,5	31,5	16	100601200
14	66,5	33	17	100601400

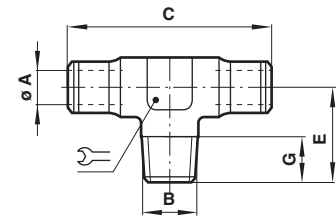
**Tee adaptor, BSP taper  
10165**

Ø A	B	C	E	G		Model
4	R1/8	34	15	7,5	7	101650418
5	R1/8	37	15,5	7,5	7	101650518
5	R1/4	40	20	11	11	101650528
6	R1/8	39	16	7,5	8	101650618
6	R1/4	40	20	11	11	101650628
8	R1/8	42,5	17	7,5	11	101650818
8	R1/4	42,5	20	11	11	101650828
8	R3/8	44	23,5	12,5	13	101650838
10	R1/4	53,5	21,5	11	13	101651028
10	R3/8	53,5	23,5	12,5	13	101651038
12	R1/4	63,5	23,5	11	16	101651228
12	R3/8	63	25	12,5	16	101651238

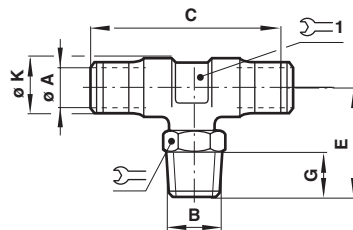
**Swivel tee adaptor, BSP taper  
10167**

Ø A	B	C	E	G	Ø K			Model
4	R1/8	34	21,5	7,5	10	10	7	101670418
4	R1/4	34	24	11	10	14	7	101670428
5	R1/8	37	22	7,5	11	11	9	101670518
5	R1/4	37	24,5	11	11	14	9	101670528
6	R1/8	39	22,5	7,5	12	11	9	101670618
6	R1/4	39	25	11	12	14	9	101670628
8	R1/8	42,5	24	7,5	14,5	14	11	101670818
8	R1/4	42,5	26	11	14,5	14	11	101670828
8	R3/8	43,5	30,5	12,5	14,5	17	13	101670838
10	R1/4	53,5	29	11	17	17	13	101671028
10	R3/8	53,5	30,5	12,5	17	17	13	101671038
10	R1/2	53,5	34,5	16	17	22	13	101671048
12	R1/4	63,5	32	11	20,5	19	16	101671228
12	R3/8	63,5	34	12,5	20,5	22	16	101671238
12	R1/2	63,5	38	16	20,5	22	16	101671248
14	R3/8	61,5	33	12,5	22,5	22	17	101671438
14	R1/2	63,5	37	16	22,5	22	17	101671448

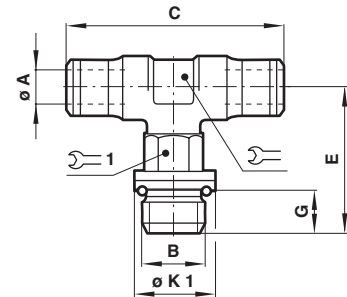
**Swivel tee adaptor, BSP parallel  
10267**

Ø A	B	C	E	G	Ø K1			Model
4	M3	34	16	3,5	-	7	8	102670403
4	M5	34	19,5	4	8	7	8	102670405
4	G1/8	34	22	5,5	14	7	11	102670418
5	M5	37	20	4	8	9	8	102670505
5	G1/8	37	22	5,5	14	9	11	102670518
5	G1/4	37	26	8	18	9	11	102670528
6	M5	39	20,5	4	8	9	8	102670605
6	G1/8	39	23	5,5	14	9	11	102670618
6	G1/4	39	26,5	8	18	9	11	102670628
8	G1/8	42,5	23,5	5,5	14	11	13	102670818
8	G1/4	42,5	29	8	18	11	17	102670828
8	G3/8	43,5	22	9	22	13	19	102670838
10	G1/4	53,5	31,5	8	18	13	17	102671028
10	G3/8	53,5	33,5	9	22	13	19	102671038
12	G1/4	63,5	35,5	8	18	16	19	102671228
12	G3/8	63,5	37	9	22	16	19	102671238
14	G1/2	63,5	39	11	26	17	24	102671448

**Tee banjo assembly, non-regulating parallel thread  
10A71**

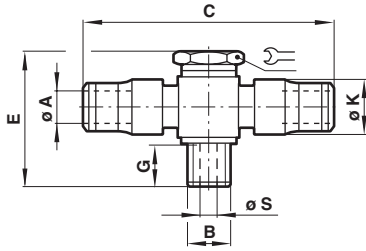

Ø A	B	C	E	G	Ø K	Ø S		Model
4	M5	37,5	22	4	9,5	2,5	8	10A710405
4	G1/8	41	30	6	11	5	14	10A710418
5	M5	40,5	22	4	11	2,5	8	10A710505
5	G1/8	43,5	30	6	11,5	5	14	10A710518
6	M5	41,5	22	4	11,5	2,5	8	10A710605
6	G1/8	47,5	30	6	12,5	5	14	10A710618
6	G1/4	48,5	34	7,5	13	8,5	17	10A710628
8	G1/8	47,5	30	6	14	5	14	10A710818
8	G1/4	49,5	34	7,5	14	8,5	17	10A710828

**Fixed side tee adaptor, BSP taper  
10175**

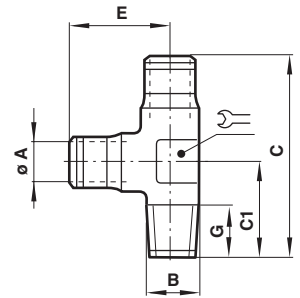

Ø A	B	C	C1	E	G		Model
4	R1/8	32	15	17	7,5	7	101750418
5	R1/8	34	15,5	18,5	7,5	7	101750518
5	R1/4	40	20	20	11	11	101750528
6	R1/8	35,5	16	19,5	7,5	8	101750618
6	R1/4	40	20	20	11	11	101750628
8	R1/8	38	17	21,5	7,5	11	101750818
8	R1/4	41,5	20	21,5	11	11	101750828
8	R3/8	45,5	23,5	22	12,5	13	101750838
10	R1/4	48,5	21,5	26,5	11	13	101751028
10	R3/8	50	23,5	26,5	12,5	13	101751038
12	R1/4	55	23,5	31,5	11	16	101751228
12	R3/8	56,5	25	31,5	12,5	16	101751238

**Swivel tee adaptor, BSP taper  
10168**

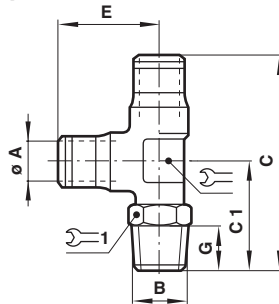

Ø A	B	C	C1	E	G			Model
4	R1/8	38,5	20,5	17	7,5	7	10	101680418
4	R1/4	41	24	17	11	7	14	101680428
5	R1/8	40,5	22	18,5	7,5	9	11	101680518
5	R1/4	43	24,5	18,5	11	9	14	101680528
6	R1/8	42	22,5	19,5	7,5	9	11	101680618
6	R1/4	44,5	25	19,5	11	9	14	101680628
8	R1/8	45	24	21,5	7,5	11	14	101680818
8	R1/4	47,5	26	21,5	11	11	14	101680828
8	R3/8	52,5	30,5	22	12,5	13	17	101680838
10	R1/4	55,5	29	26,5	11	13	17	101681028
10	R3/8	57	30,5	26,5	12,5	13	17	101681038
12	R1/4	63,5	32	31,5	11	16	19	101681228
12	R3/8	66	34	31,5	12,5	16	22	101681238
12	R1/2	70	38	31,5	16	16	22	101681248
14	R3/8	66,5	33	33	12,5	17	22	101681438
14	R1/2	70	37	33	16	17	22	101681448

**Swivel tee adaptor, BSP parallel  
10268**

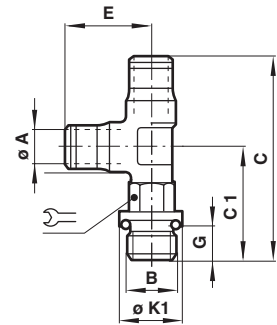

Ø A	B	C	C1	E	G	Ø K1		Model
4	M3	34	17	17	3,5	-	8	102680403
4	M5	36,5	19,5	17	4	8	8	102680405
4	G1/8	38,5	22	17	5,5	14	11	102680418
5	M5	39	20	18,5	4	8	8	102680505
5	G1/8	40,5	22,5	18,5	5,5	14	11	102680518
5	G1/4	44,5	26	18,5	8	18	11	102680528
6	G1/8	42,5	23	19,5	5,5	14	11	102680618
6	G1/4	46	26,5	19,5	8	18	11	102680628
8	G1/8	45	24	21,5	5,5	14	13	102680818
8	G1/4	50,5	29	21,5	8	18	17	102680828
8	G3/8	55	33	21,5	9	22	19	102680838
10	G1/4	58,5	31,5	26,5	8	18	17	102681028
10	G3/8	60	33,5	26,5	9	22	19	102681038
12	G1/4	67	35,5	31,5	8	18	19	102681228
12	G3/8	68,5	37	31,5	9	22	19	102681238
14	G3/8	69	36	33	9	22	19	102681438
14	G1/2	72,5	39	33	11	26	24	102681448

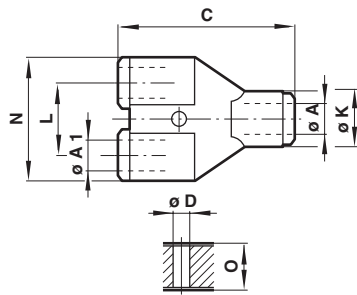
**Parallel Y-Connector  
10082**

Ø A	Ø A1	C	Ø D	L	N	Ø K	O	Model
4	4	34	3	11	22	11	10,5	100820400
6	6	38,5	3	14	27	13	12,5	100820600
6	4	38	3	14	27	13	12,5	100820604
8	8	40,5	3	16	31	15	13,5	100820800
8	6	40,5	3	16	31	15	13,5	100820806
10	10	49,5	4	20,5	42	20	15	100821000
10	8	49,5	4	20,5	42	20	15	100821008

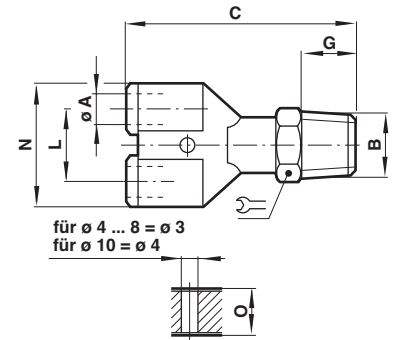
**Parallel Y-Adaptor  
10188**

Ø A	B	C	G	L	N	O	Symbol	Typ
4	R1/8	43,5	7,5	11	22,5	10,5	10	101880418
6	R1/8	48	7,5	14	28	12,5	11	101880618
8	R1/8	51	7,5	16	32	13,5	14	101880818
8	R1/4	54,5	11	16	32	13,5	11	101880828
10	R3/8	67	12,5	22	42,5	15	19	101881038
10	R1/2	70	16	22	42,5	15	22	101881048

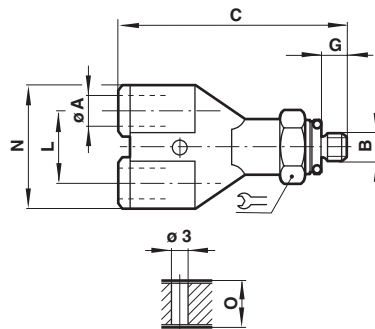
**Parallel Y-Adaptor  
10288**

Ø A	B	C	G	L	N	O	Symbol	Model
4	M5	42,5	4	11	22,5	10,5	10	102880405
6	M5	47	4	14	28	12,5	11	102880605

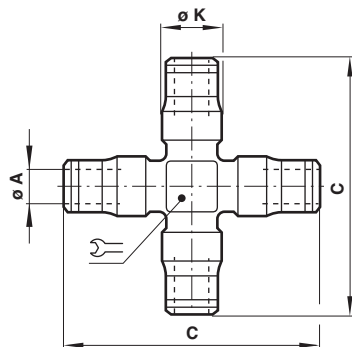
**4-way connector, tube x 4  
10090**

Ø A	C	Ø K	Symbol	Model
4	42	10,5	10	100900400
5	45,5	11	10	100900500
6	47,5	12	10	100900600
8	57,5	14,5	13	100900800
10	68,5	17	13	100901000

**Manifold  
100D6**

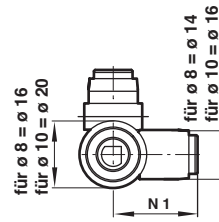
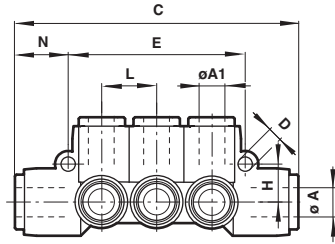

$\phi A/\phi A1$	C	$\phi D$	E	H	L	N	N1	Model
8/4	68	3,4	42	9	13	12,5	20	100D60804
8/6	68	3,4	42	9	13	12,5	20	100D60806
10/6	83	3,4	48	10,5	15	17	22,5	100D61006
10/8	83	3,4	48	10,5	15	17	22,5	100D61008

**Manifold  
100D6**

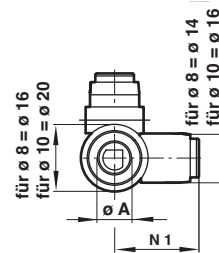
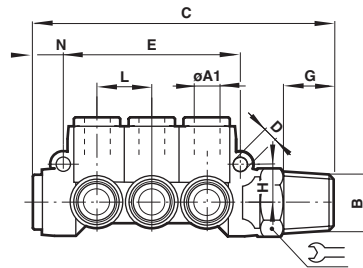

$\phi A$	$\phi A1$	B	C	$\phi D$	E	G	H	L	N	N1		Typ
8	4	R1/4	83	3,4	42	11	9	13	12,5	20	17	101D60428
8	4	R3/8	85	3,4	42	12,5	9	13	12,5	20	19	101D60438
8	6	R1/4	83	3,4	42	11	9	13	12,5	20	17	101D60628
8	6	R3/8	85	3,4	42	12,5	9	13	12,5	20	19	101D60638
10	8	R3/8	100	3,4	48	12,5	10,5	15	17	22,5	19	101D60838
10	8	R1/2	104	3,4	48	16	10,5	15	17	22,5	22	101D60848

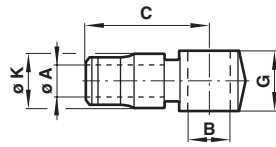
**Elbow banjo body  
10051**

Ø A	B for screw	C	G	Ø K	Model
4	M5	18,5	12,5	9,5	100510405
4	G1/8	20,5	14	11	100510418
5	M5	20	12,5	11	100510505
5	G1/8	21,5	14	11,5	100510518
6	M5	22	12,5	12,5	100510605
6	G1/8	23,5	14	12,5	100510618
6	G1/4	24	16	13	100510628
8	G1/8	23,5	14	14	100510818
8	G1/4	24,5	16	14	100510828
8	G3/8	26,5	20,5	16,5	100510838
10	G1/4	30	16	16	100511028
10	G3/8	31	20,5	17	100511038
12	G3/8	33	20,5	17,5	100511238
12	G1/2	38	22	17,5	100511248

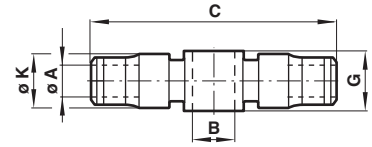
**Tee banjo body  
10071**

Ø A	B for screw	C	G	Ø K	Model
4	M5	37,5	12,5	9,5	100710405
4	G1/8	41	14	11	100710418
5	M5	40	12,5	11	100710505
5	R1/8	43	14	11,5	100710518
6	M5	41,5	12,5	11,5	100710605
6	G1/8	47,5	14	12,5	100710618
6	G1/4	48,5	16	13	100710628
8	G1/8	47,5	14	14	100710818
8	G1/4	49,5	16	14	100710828

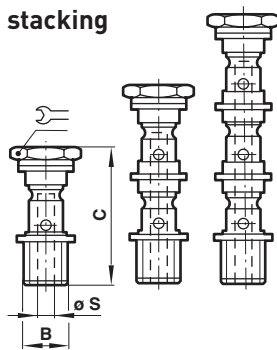
**Banjo bolt, non-regulating stacking  
20A00, 20B00, 20C00**

B	C	Ø S	Execution	⌘	Model
M5	22	2,5	single	8	20A000005
G1/8	29	5	single	14	20A000018
G1/4	33	8,5	single	17	20A000028
G3/8	41	10	single	22	20A000038
G1/2	49	11,5	single	27	20A000048
M5	34,5	2,5	double	8	20B000005
G1/8	46,5	5	double	14	20B000018
G1/4	52,5	8,5	double	17	20B000028
G3/8	64	10	double	22	20B000038
G1/2	72,5	11,5	double	27	20B000048
G1/8	63	5	triple	14	20C000018
G1/4	71,5	8,5	triple	17	20C000028
G3/8	87	10	triple	22	20C000038

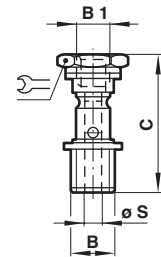
**Banjo bolt, non-regulating single stacking  
with top port BSP parallel  
20\*00**

B	B1	C	Ø S	⌘	Model
M5	M5	25,5	2,5	8	20D000505
M5	G1/4	34	8,5	17	20D000528
M5	G3/8	41	10	22	20D000538
G1/8	G1/8	36	5	14	20E001818
G1/8	G1/4	35,5	6	17	20E001828
G1/8	G3/8	41	10	22	20E001838
G1/4	G1/4	45	8,5	17	20F002828
G3/8	G3/8	52	10	22	20G003838

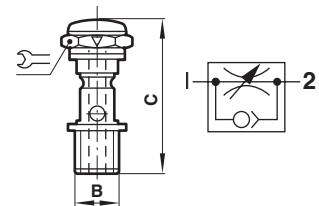
**Regulating out banjo bolts Single stacking,  
(screwdriver adjustable), Reg out  
20K00**

B	C	Operating pressure	⌘	Model
M5	27,5	10 bar	8	20K000005
G1/8	34	10 bar	14	20K000018
G1/4	36,5	10 bar	17	20K000028
G3/8	51,5	10 bar	22	20K000038
G1/2	57	10 bar	27	20K000048

**Regulating out banjo bolts, single stacking, (screwdriver adjustable), regulating in 20L00**



B	C	Operating pressure		Model
M5	27,5	10 bar	8	20L000005
G1/8	34	10 bar	14	20L000018
G1/4	36,5	10 bar	17	20L000028
G3/8	51,5	10 bar	22	20L000038
G1/2	57	10 bar	27	20L000048

**Regulating out banjo bolts, single stacking (screwdriver adjustable), bi-directional 20M00**

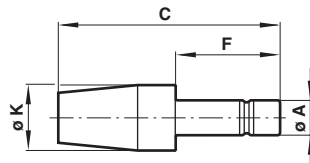
B	C	Operating pressure		Model
M5	27,3	10 bar	8	20M000005
G1/8	34	10 bar	14	20M000018
G1/4	36,5	10 bar	17	20M000028
G3/8	51,5	10 bar	22	20M000038
G1/2	57	10 bar	27	20M000048

**Silencer, plug in 10011**

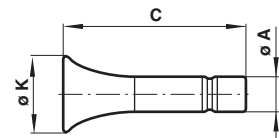
Ø A	C	F	Ø K	Model
4	31,5	16,5	11	100110400
6	33,5	18,5	11	100110600
8	40,5	19,5	13	100110800
10	53,5	24	19	100111000
12	57	27,5	19	100111200

**Plug (Acetal) 11004**

Ø A	C	Ø K	Model
4	26,5	9,5	110040400
5	28	10,5	110040500
6	28,5	11,5	110040600
8	29,5	12,5	110040800
10	34	15,5	110041000
12	37,5	16,5	110041200
14	37,5	19,5	110041400

**Warning**

These products are intended for use in industrial compressed air systems only. Do not use these products where pressures and temperatures can exceed those listed under 'Technical features'.

Before using these products with fluids other than those specified, for non-industrial applications, life-support systems, or other applications not within published specifications, consult NORGREN.

Through misuse, age, or malfunction, components used in fluid power systems can fail in various modes.

The system designer is warned to consider the failure modes of all component parts used in fluid power systems and to provide adequate safeguards to prevent personal injury or damage to equipment in the event of such failure.

System designers must provide a warning to end users in the system instructional manual if protection against a failure mode cannot be adequately provided.

System designers and end users are cautioned to review specific warnings found in instruction sheets packed and shipped with these products.