

**KA/8000/M, KA/8000**  
**Stainless steel ISO/VDMA cylinders**  
**Magnetic & non-magnetic piston, double acting**  
**Ø 32 ... 200 mm**

**High corrosion and acid resistance**

**Conforms to DIN ISO 15552, DIN ISO 6431, VDMA 24562 and NFE 49-003-1**

**Ideal for applications in the food industry**

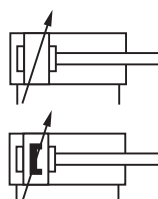

**Technical features**

**Medium:**

Compressed air, filtered, lubricated or non-lubricated

**Standard:**

DIN ISO 15552, DIN ISO 6431, VDMA 24562 and NFE 49-003-1

**Operation:**

KA/8000: Double acting, adjustable cushioning  
 KA/8000/M: Double acting, adjustable cushioning and magnetic piston

**Operating pressure:**

1 ... 16 bar

**Ports:**

G1/8 ... G3/4

**Cylinder diameters:**

32, 40, 50, 63, 80, 100, 125, 160, 200 mm

**Strokes:**

Standard: see page below

**Non-standard strokes:**

Available (2500 mm max.)

**Operating temperature:**

+80°C max.

Air supply must be dry enough to avoid ice formation at temperatures below +2°C.

**Materials:**

Barrel: X5 Cr Ni 18 10 (1.4301; AISI 304)

End covers: X10 Cr Ni S 18 9 (1.4305; AISI 303)

Piston rod: X10 Cr Ni S 18 9 (1.4305; AISI 303)

Nuts and screws: X10 Cr Ni S 18 9 (1.4305; AISI 303)

Tie rods: X5 Cr Ni Mo 17 12 2 (1.4401; AISI 316)

Piston rod seals: FPM

Piston seals:

PUR Ø 32 ... 100 mm,

NBR Ø 125 ... 200 mm

Cushion seals: NBR

O-rings: FPM

**Technical data**

Cylinder Ø (mm)	32	40	50	63	80	100	125	160	200
Air ports	G 1/8	G 1/4	G 1/4	G 3/8	G 3/8	G 1/2	G 1/2	G 3/4	G 3/4
Piston rod Ø (mm)	12	16	20	20	25	25	32	40	40
Piston rod thread	M10x1,25	M12x1,25	M16x1,5	M16x1,5	M20x1,5	M20x1,5	M27x2	M36x2	M36x2
Initial cushion volume (cm³)	19	22	24	24	27	34	41	45	45
Cushion length (mm)	12,3	20,7	36	64	116	242	451	816	1324
Theoretical thrusts at 6 bar outstroke N	482	754	1178	1870	3016	4710	7363	12064	18840
Theoretical thrusts at 6 bar instroke N	414	633	990	1680	2722	4416	6882	11310	18090
Air consumption at 6 bar outstroke l/cm	0,056	0,088	0,137	0,218	0,35	0,55	0,86	1,41	2,2
Air consumption at 6 bar instroke l/cm	0,048	0,074	0,114	0,195	0,32	0,51	0,79	1,32	2,1

**Standard strokes**

Cylinder Ø (mm)	Stroke length (mm)										
	25	50	80	100	125	160	200	250	320	400	500
32	•	•	•	•	•	•	•	•	•	•	•
40	•	•	•	•	•	•	•	•	•	•	•
50	•	•	•	•	•	•	•	•	•	•	•
63	•	•	•	•	•	•	•	•	•	•	•
80	•	•	•	•	•	•	•	•	•	•	•
100	•	•	•	•	•	•	•	•	•	•	•
125	•	•	•	•	•	•	•	•	•	•	•
160	•	•	•	•	•	•	•	•	•	•	•
200	•	•	•	•	•	•	•	•	•	•	•

## Cylinder variants

Symbol	Model Non-magnetic piston	Symbol	Model magnetic piston	Description	Dimensions
					Page
	KA/8000		KA/8000/M	Standard	4
	TKA/8000		TKA/8000/M	Cylinder with heat resistant seal (150°C max.)	4
	KA/8000/W1		KA/8000/W2	Cylinder with special wiper/seal (polyurethane) for applications with arizona sand, cement, plaster (stucco), hoar-frost or ice (Ø 32 ... 125 mm)	4
	KA/8000/W		KA/8000/MW	Cylinder without cushion	4
	KA/8000/J		KA/8000/JM	Cylinder with double ended piston rod	4
	KA/8000/W3		KA/8000/W4	Cylinder with double ended piston rod and special wiper/ seal (polyurethane) for applications with arizona sand, cement, plaster (stucco), hoar-frost or ice (Ø 32 ... 125 mm)	4

For combinations of alternative cylinders consult our technical service.

## Option selector

★KA/8★☆☆/☆☆/★★★★

Non-standard variants	Substitute
High temperature version: 150°C max.	T
Cylinder Ø	Substitute
032, 040, 050, 063, 080, 100, 125, 160, 200, 250, 320	
Variants (magnetic piston)	Substitute
Standard	M
Special wiper/seal	W2
Without cushion	MW
Double ended piston rod	JM
Double ended piston rod special wiper/seal	W4

Strokes (mm)	Substitute
2500 max.	
Variants (non-magnetic piston)	Substitute
Standard	None
Special wiper/seal	W1
Without cushion	W
Double ended piston rod	J
Double ended piston rod special wiper/seal	W3

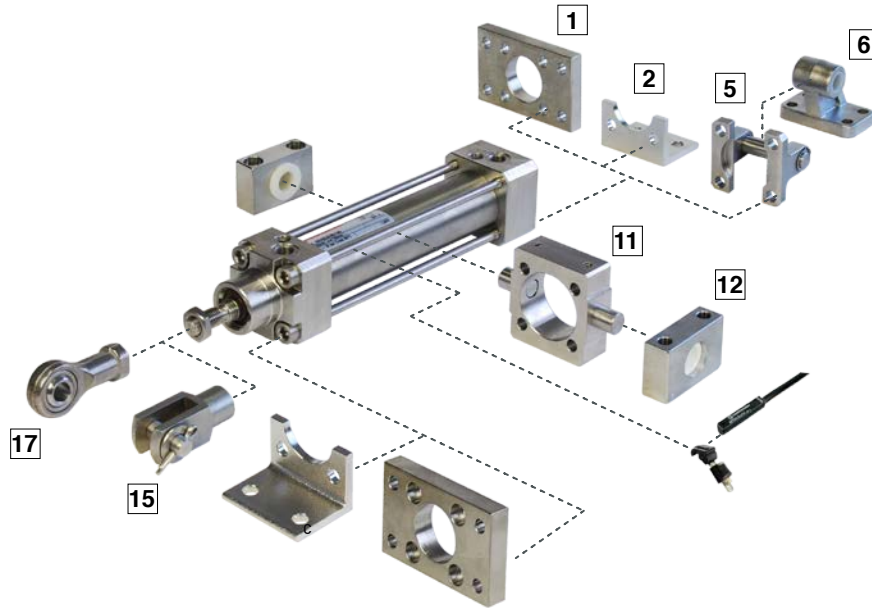
**Mountings**

Position	Style	Stainless steel	Position	Style	Standard
1	B, G	X 5 Cr Ni 18 10 (1.4301; AISI 304). Screws: A2	12	S	Swivel bearing: X 5 Cr Ni 18 10 (1.4301; AISI 304), bearing: PA
2	C	X 5 Cr Ni 18 10 (1.4301; AISI 304). Screws: A2	15	F	Clevis mounting: X 10 Cr Ni S 18 9 (1.4305; AISI 303), Bolt: X 10 Cr Ni S 18 9 (1.4305; AISI 303), Circclip: X 10 Cr Ni S 18 9 (1.4305; AISI 303)
5	D	X 5 Cr Ni 18 10 (1.4301; AISI 304). Screws: A2 Bolt: X 10 Cr Ni S 18 9 (1.4305; AISI 303)	17	UF	X 10 Cr Ni S 18 9 (1.4305; AISI 303), Inner ring X 105 Cr Co Mo 18-2 (1.4528), Outer ring X 5 Cr Ni 18 10 (1.4301; AISI 304)
6	SW	X 6 Cr Ni 18 9 (1.4308; AISI 304)		Bracket for switches	Body: PA/PP, screw and holding strap A2
11	UH	Adjustable intermediate mounting: X 10 Cr Ni S 18 9 (1.4305; AISI 303), Bolts: X 10 Cr Ni S 18 9 (1.4305; AISI 303), screws: A2			

	B, G	C	D	F	S	SW	UF	UH
Cyl. Ø	1 Page 5	2 Page 5	5 Page 5	15 Page 5	12 Page 6	6 Page 6	17 Page 6	11 Page 6
32	KQA/8032/22	KQA/8032/21	KQA/8032/23	KQM/55433/25	KQA/8032/41	M/P72288	KQM/8032/32	KQA/8032/40
40	KQA/8040/22	KQA/8040/21	KQA/8040/23	KQM/55441/25	KQA/8040/41	M/P72289	KQM/8040/32	KQA/8040/40
50	KQA/8050/22	KQA/8050/21	KQA/8050/23	KQM/55451/25	KQA/8040/41	M/P72290	KQM/8050/32	KQA/8050/40
63	KQA/8063/22	KQA/8063/21	KQA/8063/23	KQM/55451/25	KQA/8063/41	M/P72291	KQM/8050/32	KQA/8063/40
80	KQA/8080/22	KQA/8080/21	KQA/8080/23	KQA/8080/25	KQA/8063/41	M/P72292	KQM/8080/32	KQA/8080/40
100	KQA/8100/22	KQA/8100/21	KQA/8100/23	KQA/8080/25	KQA/8100/41	M/P72293	KQM/8080/32	KQA/8100/40
125	KQA/8125/22	KQA/8125/21	KQA/8125/23	KQA/8125/25	KQA/8100/41	-	KQM/8125/32	KQA/8125/40

	M/50/**	Switch mounting brackets for M/50	Service kit for M/50
Cyl. Ø	Page 7 + 8	Page 8	
32		QM/27/2/1	KQA/8032/00
40		QM/27/2/1	KQA/8040/00
50		QM/27/2/1	KQA/8050/00
63		QM/27/2/1	KQA/8063/00
80		QM/27/2/1	KQA/8080/00
100		QM/27/2/1	KQA/8100/00
125		QM/27/2/1	KQA/8125/00
160		QM/27/2/1	KQA/8160/00
200		QM/27/2/1	KQA/8200/00

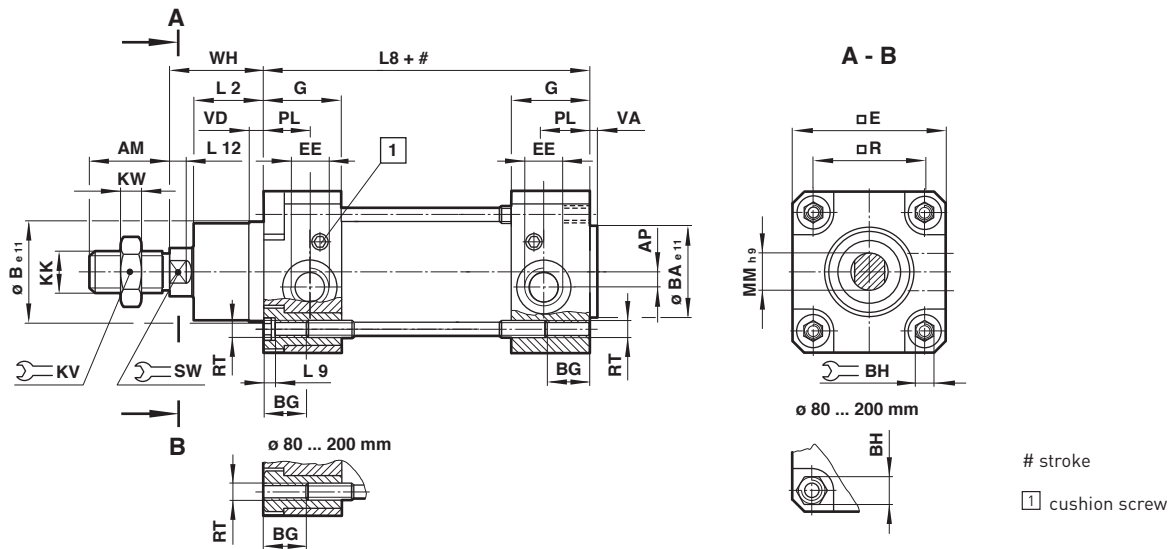
**Basic dimensions**

∅	AM	AP	∅ Be11	∅ BAe11	BG	BH	□ E	EE	G	KK	⊕ KV	KW	L2	L8	L9
32	22	3,5	30	30	18	6	47	G 1/8	27,5	M10x1,25	17	5	20	94	4
40	24	4,5	35	35	18	6	53	G 1/4	32	M12x1,25	19	6	22	105	4
50	32	6	40	40	18	8	65	G 1/4	31	M16x1,5	24	8	27	106	5
63	32	10	45	45	17,5	8	75	G 3/8	33	M16x1,5	24	8	29	121	5
80	40	8,5	45	45	21,5	19	95	G 3/8	33	M20x1,5	30	10	33	128	-
100	40	9	55	55	21,5	19	115	G 1/2	37	M20x1,5	30	10	36	138	-
125	54	10	60	60	32	24	140	G 1/2	46	M27x2	41	13,5	45	160	-
160	72	18	65	65	28,5	32	180	G 3/4	50	M36x2	55	18	58	180	-
200	72	18	75	75	28,5	32	220	G 3/4	50	M36x2	55	18	67	180	-
∅	L12	∅ MMh 9	PL	□ R	RT	⊕ SW	VA	VD	WH	at 0 mm	per 25 mm	Model non-magnetic piston	Model magnetic piston		
32	6	12	13	32,5	M 6	10	3	6	26	1,12 kg	0,06 kg	KA/8032/*	KA/8032/M/*		
40	6,5	16	15	38	M 6	13	3,5	6	30	1,65 kg	0,08 kg	KA/8040/*	KA/8040/M/*		
50	8	20	18,5	46,5	M 8	17	3,5	6	37	2,57 kg	0,13 kg	KA/8050/*	KA/8050/M/*		
63	8	20	19	56,5	M 8	17	4	6	37	3,95 kg	0,14 kg	KA/8063/*	KA/8063/M/*		
80	10	25	19	72	M 10	22	4	6	46	6,64 kg	0,30 kg	KA/8080/*	KA/8080/M/*		
100	10	25	20,5	89	M 10	22	4	6	51	10,67 kg	0,34 kg	KA/8100/*	KA/8100/M/*		
125	13	32	20,5	110	M 12	27	6	15,5	65	20,82 kg	0,51 kg	KA/8125/*	KA/8125/M/*		
160	16	40	21	140	M 16	36	4	15	80	37,3 kg	0,88 kg	KA/8160/*	KA/8160/M/*		
200	16	40	21	175	M 16	36	5	15	95	59,0 kg	1,14 kg	KA/8200/*	KA/8200/M/*		

\* Please insert standard stroke length.

**Cylinder variants**
**KA/8000/J, KA/8000/JM – Cylinder with double ended piston rod**

∅	ZM	at 0 mm	per 25 mm	Model non-magnetic piston	Model magnetic piston
32	146	1,17 kg	0,08 kg	KA/8032/J/.	KA/8032/JM/.
40	165	1,80 kg	0,12 kg	KA/8040/J/.	KA/8040/JM/.
50	180	2,81 kg	0,19 kg	KA/8050/J/.	KA/8050/JM/.
63	195	4,22 kg	0,20 kg	KA/8063/J/.	KA/8063/JM/.
80	220	7,18 kg	0,40 kg	KA/8080/J/.	KA/8080/JM/.
100	240	11,21 kg	0,44 kg	KA/8100/J/.	KA/8100/JM/.
125	290	21,94 kg	0,67 kg	KA/8125/J/.	KA/8125/JM/.
160	340	39,54 kg	1,13 kg	KA/8160/J/.	KA/8160/JM/.
200	370	61,39 kg	1,39 kg	KA/8200/J/.	KA/8200/JM/.

# Please insert standard stroke length.

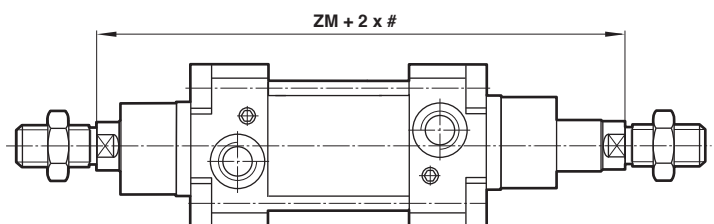

**Mountings**
**Front flange B, G**

Conforms to ISO 15552, type MF1 and MF2

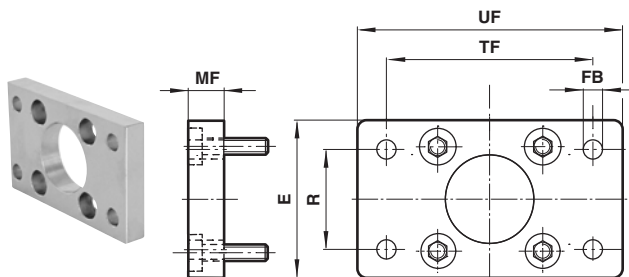

∅	E	∅ FB	MF	R	TF	UF	kg	Model (B, G)
32	50	7	10	32	64	80	0,26	KQA/8032/22
40	55	9	10	36	72	90	0,31	KQA/8040/22
50	65	9	12	45	90	110	0,56	KQA/8050/22
63	75	9	12	50	100	125	0,73	KQA/8063/22
80	100	12	16	63	126	154	1,73	KQA/8080/22
100	120	14	16	75	150	186	2,51	KQA/8100/22

**Foot mounting C**

Conforms to ISO 15552, type MS1

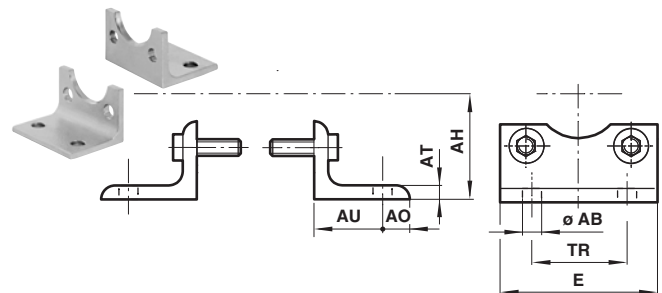

∅	∅ AB	AH	AO	AT	AU	E	TR	kg	Model (C)
32	7	32	11	4	24	48	32	0,16	KQA/8032/21
40	9	36	12	5	28	53	36	0,19	KQA/8040/21
50	9	45	13	5	32	64	45	0,32	KQA/8050/21
63	9	50	13	5	32	74	50	0,41	KQA/8063/21
80	12	63	19	6	41	98	63	0,83	KQA/8080/21
100	14	71	19	6	41	115	75	0,98	KQA/8100/21

**Rear clevis D**

Conforms to ISO 15552, type MP2

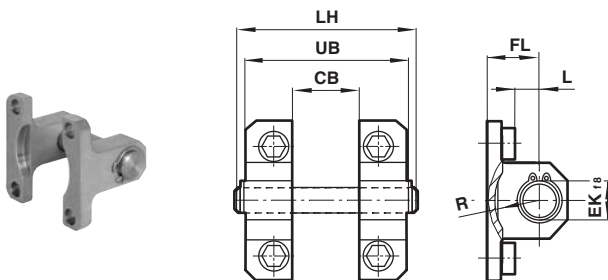

∅	CB <sup>H14</sup>	∅ EK <sup>18</sup>	FL	L	LH	R	UB	kg	Model (D)
32	26	10	22	13	52	9	45	0,11	KQA/8032/23
40	28	12	25	16	60	12	52	0,16	KQA/8040/23
50	32	12	27	17	68	12	60	0,22	KQA/8050/23
63	40	16	32	22	79	15	70	0,34	KQA/8063/23
80	50	16	36	22	99	15	90	0,54	KQA/8080/23
100	60	20	41	27	119	20	110	0,9	KQA/8100/23

**Piston rod clevis F**

Conforms to DIN ISO 8140

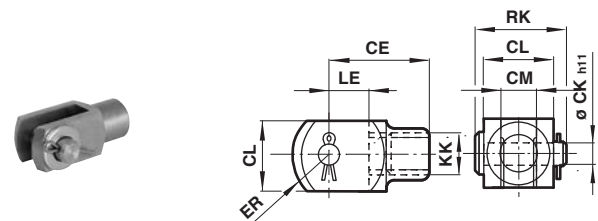

∅	KK	CE	∅ CK <sub>h11</sub>	CL	CM	ER	LE	RK	kg	Model (F)
32	M10x1,25	40	10	20	10	16	20	28	0,09	KQM/55433/25
40	M12x1,25	48	12	24	12	19	24	32	0,13	KQM/55441/25
50/63	M16x1,5	64	16	32	16	25	32	41,5	0,33	KQM/55451/25
80/100	M20x1,5	80	20	40	20	32	40	50	0,67	KQM/8080/25

### Trunnion support S

Conforms to ISO 15552, type AT4

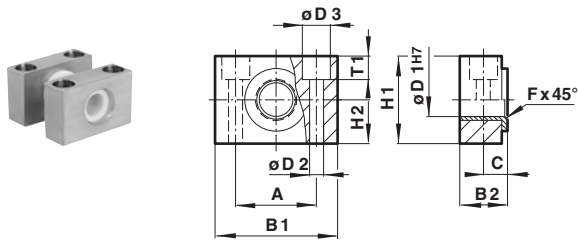

Ø	A	B1	B2	C	Ø D1 <sup>H7</sup>	Ø D2	Ø D3	Fx 45°	H1	H2	T1	kg	Model (S)
32	32	46	18	10,5	12	6,6	11	1	30	15	6,8	0,1	KQA/8032/41
40/50	36	55	21	12	16	9	15	1,6	36	18	9	0,14	KQA/8040/41
63/80	42	65	23	13	20	11	18	1,6	40	20	11	0,18	KQA/8063/41
100/125	50	75	28,5	16	25	14	20	2	50	25	13	0,34	KQA/8100/41

### Wide hinge SW

Conforms to ISO 15552, type AB7

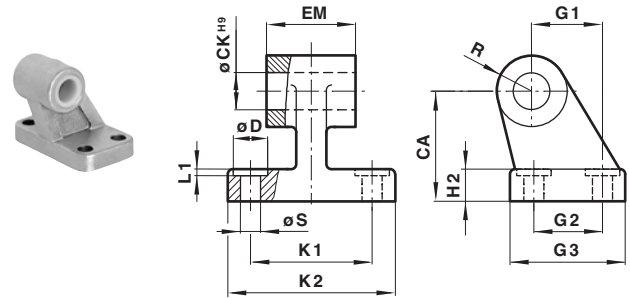

Ø	CA	Ø CK <sup>H9</sup>	Ø D	EM	G1	G2	G3	H2	K1	K2	L1	R	Ø S	kg	Model (SW)
32	32	10	11	26	21	18	31	8	38	51	1,6	10	6,6	0,15	M/P72288
40	36	12	11	28	24	22	35	10	41	53	1,6	11	6,6	0,21	M/P72289
50	45	12	15	32	33	30	45	12	50	65	1,6	13	9	0,41	M/P72290
63	50	16	15	40	37	35	50	12	52	67	1,6	15	9	0,53	M/P72291
80	63	16	18	50	47	40	60	14	66	86	2,5	15	11	0,82	M/P72292
100	71	20	18	60	55	50	70	15	76	96	2,5	19	11	1,22	M/P72293

### Universal piston rod eye UF

Conforms to DIN ISO 8139

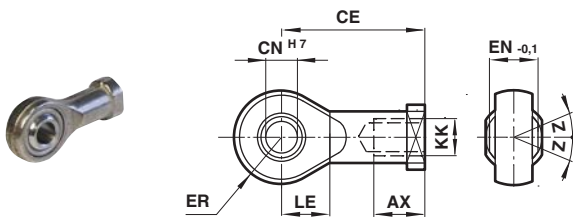

Ø	Thread KK	AX	CE	Ø CN <sup>H7</sup>	EN <sup>-0,1</sup>	ER	LE	Z	kg	Model (UF)
32	M10x1,25	20	43	10	14	14,5	14	13°	0,07	KQM/8032/32
40	M12x1,25	22	50	12	16	16,5	16	13°	0,11	KQM/8040/32
50/63	M16x1,5	28	64	16	21	21,5	21	15°	0,21	KQM/8050/32
80/100	M20x1,5	33	77	20	25	25,5	25	15°	0,38	KQM/8080/32

### Adjustable trunnion mounting UH

Conforms to ISO 15552, type MT4

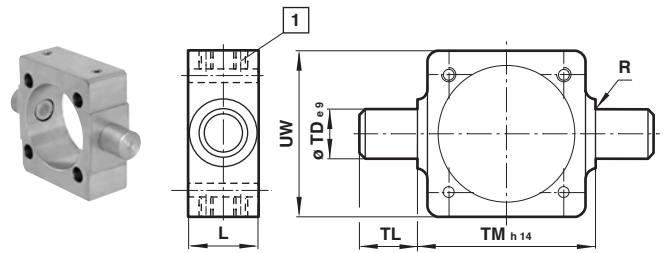

1 Locking screws  
Torque max: Ø 32 & 40 mm = 6 Nm; Ø 50 & 63 mm = 10 Nm;  
Ø 80 & 100 mm = 15 Nm; Ø 125 mm = 25 Nm

Ø	L	R	Ø TD <sub>e9</sub>	TL	TM <sub>h14</sub>	UW	XV min.	XV max.	kg	Model (UH)
32	20	1	12	12	50	53	63,5	82,5	0,24	KQA/8032/40
40	24	1,6	16	16	63	65	74	91	0,48	KQA/8040/40
50	28	1,6	16	16	75	75	82	98	0,7	KQA/8050/40
63	28	1,6	20	20	90	95	84	111	1,35	KQA/8063/40
80	28	1,6	20	20	110	115	93	127	1,46	KQA/8080/40
100	38	2	25	25	132	140	112	128	2,76	KQA/8100/40
125	50	2	25	25	160	143	136	154	3,28	KQA/8125/40

Style 'UH': It is most important that the locking screws which secure the mounting to the tie rod are tightened to the torque figures shown in the table below. For maximum energy input, consult our Technical Service. Unless otherwise specified, units will be supplied with dimension 'XV' plus half the stroke length. 'XV' = Distance from the piston rod shoulder to the centre of the mounting.

**Technical data - Reed switches - additional informations see data sheet N/en 4.3.005**

Symbol	Voltage (V a.c.) (V d.c.)	Current max. (mA)	Function	Temperature (°C)	LED	Protection class	Features	Cable length (m)	Cable type	Weight (g)	Model	
± BN	10 ... 240	10 ... 170	180	Closer	-25 ... +80	•	IP66	—	2, 5 or 10	PVC 2 x 0,25	37	M/50/LSU/*V
~ BU	10 ... 240	10 ... 170	180	Closer	-25 ... +80	•	IP66	—	5	PUR 2 x 0,25	37	M/50/LSU/5U
BN BU	10 ... 240	10 ... 170	180	Closer	-25 ... +150	—	IP66	—	2	Silicon 2 x 0,25	37	TM/50/RAU/2S
BK BU BN	10 ... 240	10 ... 170	180	Changeover	-25 ... +80	—	IP66	—	5	PVC 3 x 0,25	37	M/50/RAC/5V
± BN 4 ~ BK	10 ... 60	10 ... 60	180	Closer	-25 ... +80	•	IP66	Plug M8 x 1	0,3	PVC 3 x 0,25	16	M/50/LSU/CP *1)

\* Insert cable length; \*1) Plug-in connector see page 11; Color code: BK = black, BN = brown, BU = blue

**Dimensions**

**M/50/LSU/\*V, M/50/LSU/5U, TM/50/RAU/2S**

Cable length L = 2, 5 or 10 m

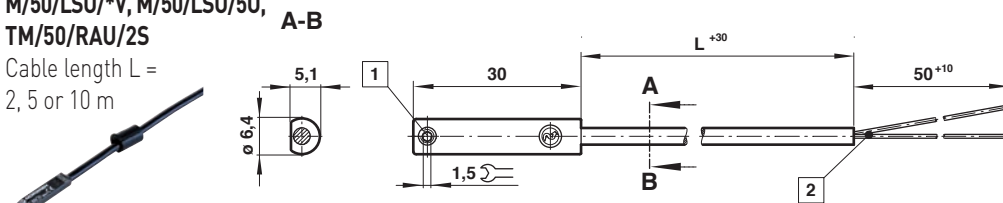

- 1 Fixing screw
- 2 + BN = brown  
- BU = blue  
(output)

**M/50/RAC/5V**

Cable length L = 5 m

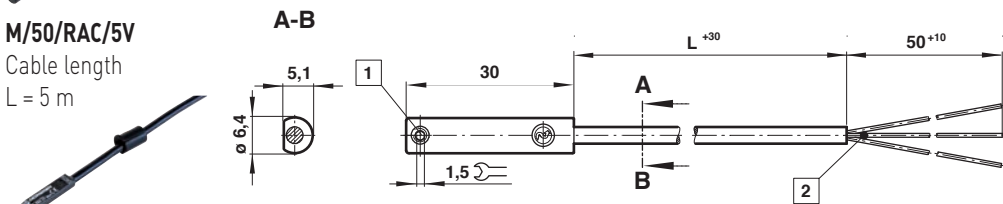

- 1 Fixing screw
- 2 - BK = black  
+ BN = brown  
- ≠BU = blue

**M/50/LSU/CP**

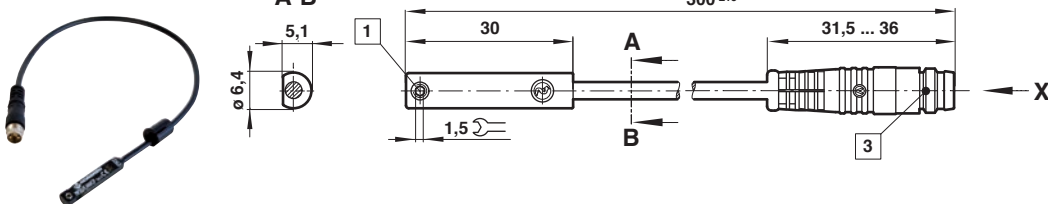

- 1 Fixing screw
- 2 - BK = black  
+ BN = brown  
- ≠BU = blue
- 3 Plug M8x1
- Color code  
BK = black  
BN = brown  
BU = blue

**Accessories**

Plug-in connector cable with nut



Outer cover	Cable length	Weight (kg)	Connector	Model
PVC 3 x 0,25	5 m	0,18	M8 x 1	M/P73001/5
PUR 3 x 0,25	5 m	0,18	M8 x 1	M/P73002/5
PUR 3 x 0,34	5 m	0,21	M12 x 1	M/P34594/5

Technical data - Solid state - additional informations see data sheet N/en 4.3.007

Symbol	Voltage (V d.c.)	Current max. (mA)	Function	Temperature (°C)	LED	Protection class	Features	Cable length (m)	Cable type	Weight (g)	Model
	10 ... 30	150	PNP	-40 ... +80	•	IP67	—	2, 5 or 10	PVC 3 x 0,12	37	M/50/EAP/*V
	10 ... 30	150	PNP	-40 ... +80	•	IP68	—	5	PUR 3 x 0,14	37	M/50/EAP/5U
	10 ... 30	150	PNP	-40 ... +80	•	IP67	Plug M8 x 1	0,3	PVC 3 x 0,14	16	M/50/EAP/CP *1)
	10 ... 30	150	PNP	-40 ... +80	•	IP67	Plug M12 x 1	0,3	PVC 3 x 0,14	16	M/50/EAP/CC *1)
	10 ... 30	150	NPN	-40 ... +80	•	IP67	—	2, 5 or 10	PVC 3 x 0,12	37	M/50/EAN/*V
	10 ... 30	150	Closer	-40 ... +80	•	IP67	Plug M8 x 1	0,3	PVC 3 x 0,14	16	M/50/EAN/CP *1)

\* Insert cable length; \*1) Plug-in connector below; Color code: BK = black, BN = brown, BU = blue

Dimensions

M/50/EAP/\*V,  
M/50/EAN/\*V

Cable length L =  
2, 5 or 10 m

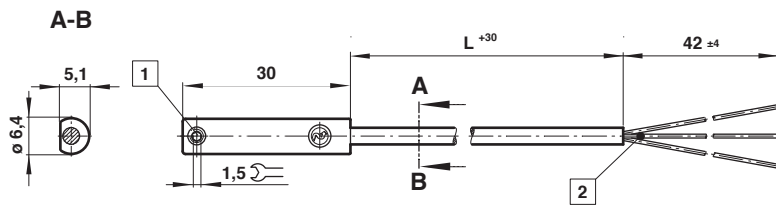

M/50/EAP/CP,  
M/50/EAN/CP

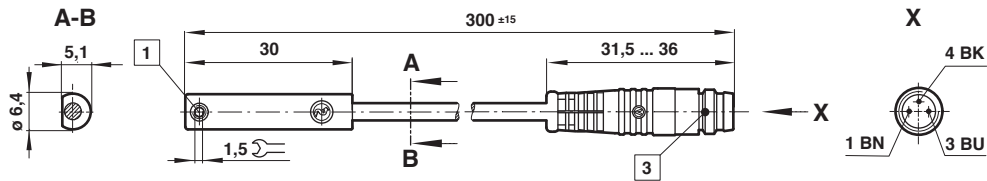

M/50/EAP/CC

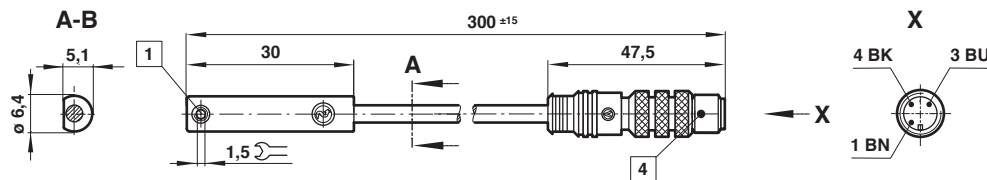

- 1 Fixing screw
- 2 Color code  
BK = black  
BN = brown  
BU = blue
- 3 Plug M8 x 1
- 4 Plug M12 x 1

QM/27/2/1 – Switch mounting brackets

Switch: M/50

Cylinder Ø	A	B	Weight (kg)	Model
32	9	7	0,010	QM/27/2/1
40	8	8	0,010	QM/27/2/1
50	7	5	0,010	QM/27/2/1
63	7	7	0,010	QM/27/2/1
80	7	4	0,010	QM/27/2/1
100	2	2	0,010	QM/27/2/1
125	-4	-3	0,010	QM/27/2/1
160	-10	-9	0,010	QM/27/2/1
200	-17	-14	0,010	QM/27/2/1

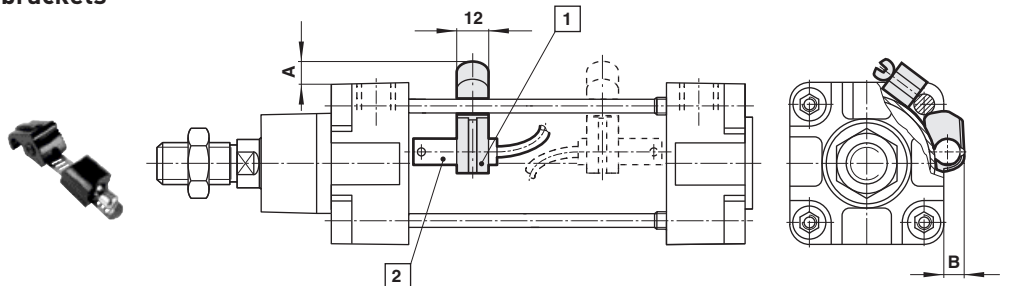

- 1 Switch mounting bracket
- 2 Magnetically operated switch



## Warning

These products are intended for use in industrial compressed air systems only. Do not use these products where values can exceed those listed under »**Technical features/data**«.

Before using these products with fluids other than those specified, for non-industrial applications, life-support systems, or other applications not within published specifications, consult NORGREN.

Through misuse, age, or malfunction, components used in fluid power systems can fail in various modes.

The system designer is warned to consider the failure modes of all component parts used in fluid power systems and to provide adequate safeguards to prevent personal injury or damage to equipment in the event of such failure.

System designers must provide a warning to end users in the system instructional manual if protection against a failure mode cannot be adequately provided.

System designers and end users are cautioned to review specific warnings found in instruction sheets packed and shipped with these products.